

Ages
18+

P99 RAM, RAM X50, RAM Combat, RAM Desert Eagle

OWNER'S OPERATION MANUAL



- .43 Caliber
- CO₂ Powered
- Shoots Paintballs & Rubberballs
- Velocity 290 fps - P99 RAM™
- Velocity 250 fps - RAM X50™
- Velocity 250 fps - RAM Combat™
- Velocity 270 fps - RAM Desert Eagle™



⚠ CAUTION: MAY BE DANGEROUS UP TO 250 YARDS (229 METERS) OR THE LENGTH OF OVER TWO FOOTBALL FIELDS.

Read this owner's manual completely. This marker is not a toy. Treat it with the same respect you would a firearm. Always carefully follow the safety instructions found in this owner's manual and keep this manual in a safe place for future use.

⚠ WARNING: THIS MARKER IS NOT A TOY. MISUSE MAY CAUSE SERIOUS INJURY OR DEATH. EYE AND EAR PROTECTION DESIGNED SPECIFICALLY FOR PAINTBALL MUST BE WORN BY THE USER AND PERSONS WITHIN RANGE. PURCHASER MUST BE 18 YEARS OR OLDER. PERSONS UNDER 18 MUST HAVE ADULT SUPERVISION. READ OWNER'S MANUAL BEFORE USING.

⚠ WARNING: THIS MARKER CAN CAUSE SERIOUS INJURY OR DEATH. READ AND FOLLOW THE INSTRUCTIONS CAREFULLY. DO NOT LOAD A PROJECTILE INTO THE MARKER UNTIL YOU ARE READY TO SHOOT. IF YOU DO LOAD A PROJECTILE AND THEN DECIDE NOT TO SHOOT, REMOVE IT BY SHOOTING THE MARKER AT A SAFE TARGET. AN UNLOADED MARKER WHICH IS "ON SAFE" IS SAFEST. ACCIDENTS HAPPEN FAST, FATALLY WOUNDING SOMEONE IS A TERRIBLE THING. PLEASE SHOOT SAFELY.

Markers differ in their operation and you are never ready to fire any gun until you are thoroughly familiar with it. Read the following operating instructions thoroughly prior to operating.

These symbols, ⚠, ⚠, mark warnings and cautions in this operation manual. Carefully follow them for your own safety and the safety of others.

⚠ CAUTION: EYE PROTECTION DESIGNED SPECIFICALLY FOR PAINTBALL MUST BE WORN BY THE USER AND PERSONS WITHIN RANGE. READ ALL INSTRUCTIONS BEFORE USING.

Operating Procedures

- | | |
|---|---|
| 1. Learning the Parts of Your Marker | 7. Use and Handling of CO ₂ Capsules |
| 2. Operating the Safety | 8. Maintenance and Storage |
| 3. Removing and Installing CO ₂ Capsules | 9. Troubleshooting |
| 4. Loading and Unloading Projectiles | 10. Reviewing Safety |
| 5. Aiming and Firing Safely | 11. Repair / Service / Warranty |
| 6. Adjusting the Sights | |

⚠ CAUTION: UNAUTHORIZED MODIFICATIONS OF THIS CO₂ MARKER MAY RESULT IN A DIFFERENT LEGAL CLASSIFICATION AND ARE THEREFORE NOT PERMITTED. THE MANUFACTURER'S WARRANTY WILL BECOME NULL AND VOID IN SUCH CASES.

⚠ ATTENTION: Before using, first clean the barrel to remove the protective grease. Refer to page 12 in this manual for barrel cleaning instructions.

1. Learning the Parts of Your Marker

Learning the names of the parts of your marker will help you understand your owner's manual. Use this manual to increase your enjoyment of this marker.

Fig. 1A



- | | | |
|---------------------|---------------------------------------|-------------------|
| 1 Muzzle | 7 Trigger | 13 Loading port |
| 2 Front sight | 8 Safety | 14 Follower |
| 3 Slide | 9 Magazine Release Lever | 15 Cleaning cloth |
| 4 Slide catch | 10 Grip | 16 Barrel cleaner |
| 5 De-cocking button | 11 Magazine | 17 Accessory Rail |
| 6 Rear sight | 12 CO ₂ gas capsule holder | |

Fig. 1B



- | | | |
|--------------------|---------------------------|---------------------------------------|
| 1 Muzzle | 7 Hammer | 13 CO ₂ gas capsule holder |
| 2 Front sight | 8 Trigger | 14 Loading port |
| 3 Slide | 9 Safety | 15 Follower |
| 4 Slide catch | 10 Magazine Release Lever | 16 Cleaning cloth |
| 5 De-cocking lever | 11 Grip | 17 Barrel cleaner |
| 6 Rear sight | 12 Magazine | 18 Accessory Rail |

Fig. 1C

RAM Combat

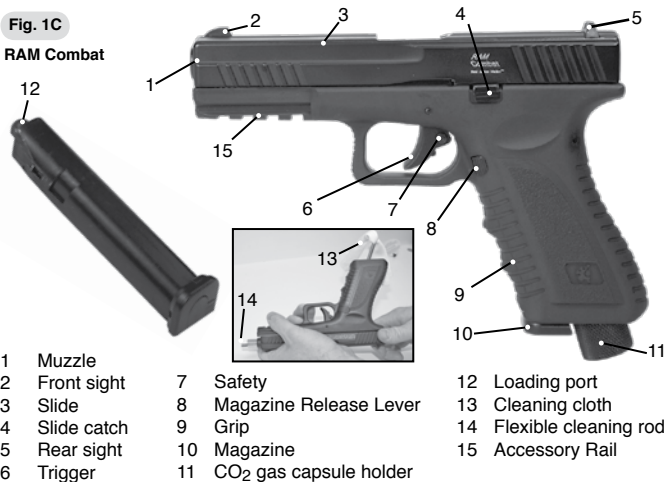

Fig. 1D

RAM Desert Eagle



2. Operating the Safety

⚠ WARNING: BE SURE THE MARKER IS ALWAYS POINTED IN A SAFE DIRECTION. NEVER POINT THE MARKER AT ANYTHING YOU DO NOT INTEND TO SHOOT. ALWAYS ASSUME AND HANDLE THE MARKER AS IF IT WERE LOADED AND READY TO FIRE.

2A. To Put the RAM P99, RAM X50, and RAM Combat "ON SAFE"

- Locate the safety at the rear of the trigger.
- Push the safety from left to right until no red is showing. (Fig. 2A) The safety is not "ON SAFE" unless it is pushed all the way in and the RED is NOT showing.

Red is NOT showing: "ON SAFE"

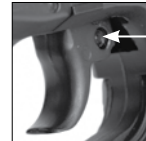

Fig. 2A

2B. To Take the RAM P99, RAM X50, and RAM Combat "OFF SAFE"

- Locate the safety at the rear of the trigger.
- Push the safety from right to left. (Fig. 2B). When you can see the RED the airgun marker is "OFF SAFE" and can be fired.

Red is showing: "OFF SAFE"



Fig. 2B

2C. To Put the RAM Desert Eagle "ON SAFE"

- Locate the safety at the rear of the slide.
- Push the safety lever down until no red is showing. (Fig. 2C)

Red is NOT showing: "ON SAFE"



Fig. 2C

2D. To Take the RAM Desert Eagle "OFF SAFE"

- Locate the safety at the rear of the slide.
- Push the safety up. (Fig. 2D). When you can see the RED the airgun marker is "OFF SAFE" and can be fired.

Red is showing: "OFF SAFE"



Fig. 2D

⚠ CAUTION: LIKE ALL MECHANICAL DEVICES, A MARKER SAFETY CAN FAIL. EVEN WHEN THE SAFETY IS "ON SAFE", YOU SHOULD CONTINUE TO HANDLE THE MARKER SAFELY. NEVER POINT THE MARKER AT ANYTHING YOU DO NOT INTEND TO SHOOT. ONLY HANDLE THE MARKER WHEN IT IS IN ITS DECOCKED CONDITION.

3. Removing and Installing CO₂ Capsules

⚠ CAUTION: COCK THE SLIDE BEFORE INSERTING THE CAPSULE. THE STRIKER MUST BE COCKED.

3A. Installing a New CO₂ Capsule

- Put the marker "ON SAFE" (See **Step 2**).
- Remove the magazine and make sure the marker is unloaded.
- Unscrew and remove the gas capsule holder by turning the holder knob counterclockwise (**Fig. 3A**).
- If a CO₂ capsule is already installed, see **Step 3B** - Removing a CO₂ Capsule.
- Before installing a CO₂ capsule, place one drop of RAM Oil on the top of the small end of the CO₂ capsule.
- Insert the CO₂ capsule into the gas capsule holder, bottom end first, with the small neck of the capsule pointing upward (**Fig. 3B**).
- Cock the marker by pulling the slide back. (**Fig. 5A**). The slide must be cocked before inserting the capsule.
- Insert the gas capsule holder with a full capsule into the grip. (**Fig. 3C**).
- Tighten the capsule holder by turning clockwise
- After puncturing the CO₂ capsule, you may hear gas escaping, point the marker in a safe direction and fire 3-4 times to seal the o-rings. (**Fig. 3C**).

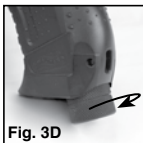
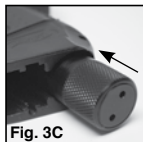
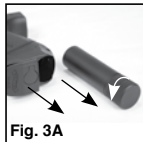

NOTE: Never try to force any CO₂ capsule into or out of place. Do not store your marker with a CO₂ capsule in it. If you know you will not be using your marker for an extended period of time, empty the CO₂ capsule and remove it from the marker. (See **Step 3B**). This is very important to remember, as it will prolong the longevity of your marker seals.

⚠ WARNING: USE ONLY CO₂ CAPSULES. ANY ATTEMPT TO USE OTHER TYPES OF GAS CAPSULES COULD BE EXTREMELY DANGEROUS AND COULD RESULT IN SERIOUS INJURY OR DEATH. GASSES OTHER THAN CO₂ COULD RESULT IN AN EXPLOSION OR RUPTURE OF THE MARKER.

⚠ WARNING: KEEP HANDS AND FACE AWAY FROM ESCAPING GAS OF THE CO₂ CAPSULE. ESCAPING CO₂ GAS IS VERY COLD AND CAN CAUSE SERIOUS INJURY TO YOU OR OTHERS. ALWAYS WEAR EYE AND HAND PROTECTION WHEN ATTACHING OR REMOVING CO₂ CAPSULES.

3B. Removing a CO₂ Capsule

- Put the marker "ON SAFE" (See **Step 2**).
- Make sure the magazine is out and the marker is unloaded (See **Step 4B**).
- Point the marker in a SAFE DIRECTION.
- Put the marker "OFF SAFE" (See **Step 2**).
- Fire the marker until it will not fire, indicating the gas capsule is empty.
- Put the marker "ON SAFE".
- Decock the marker by pressing the button at the rear of the slide just in front of the rear sight on the P99 RAM (**Fig. 4A**). The RAM X50 has a decocking lever (**Fig. 4B**). (The RAM Combat and RAM Desert Eagle do not have a decocking mechanism.)
- Use one hand to hold the marker at the top of the receiver. Use your other hand to remove the CO₂ capsule holder. Be sure to keep the muzzle pointed in a safe direction.
- Slowly turn the CO₂ capsule holder counterclockwise (down) until it stops turning; allowing any remaining CO₂ gas to escape.
- Remove the empty CO₂ capsule and discard.
- Point in a safe direction and fire to discharge any remaining gas.

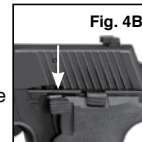
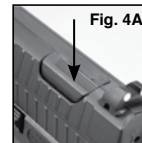

4. Loading and Unloading Projectiles

4A. Loading Paintballs or Rubberballs

- Make sure the marker is "ON SAFE" (See **Step 2**).
- Always point the marker in a SAFE DIRECTION.
- Cock the marker by pulling the slide back (**Fig. 5A**).
- Remove the magazine by pressing the magazine release button and pulling the magazine from the bottom of the grip frame.
- Pull the follower down and lock it at the side (**Fig. 5B** - RAM P99, Combat and X50). (**Fig. 5C** - RAM Desert Eagle)

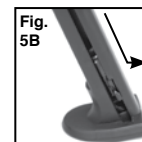

- Load up to 9 (.43 caliber) projectiles through the magazine loading port (**Fig. 5D**). (The RAM Combat and RAM Desert Eagle will only hold 8 projectiles.)
- Release the follower.
- Insert the loaded magazine back into the bottom of the grip frame until it locks in place.

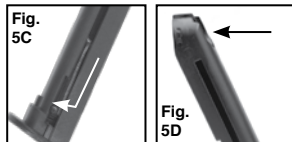

⚠ CAUTION: ALWAYS POINT THE MUZZLE IN A SAFE DIRECTION. NEVER PLACE YOUR HAND IN FRONT OF THE MUZZLE. KEEP HANDS AND FINGERS CLEAR OF SLIDE MOVEMENT AS THE RELOADING ACTION COULD CAUSE INJURY. SHOULD A PAINTBALL BURST INSIDE THE MARKER ALL RESIDUES MUST BE REMOVED BEFORE THE MARKER IS FIRED (SEE SECTION 8. MAINTENANCE AND STORAGE).

⚠ CAUTION: USE ONLY FLAWLESS .43 CALIBER PAINTBALLS OR RUBBERBALLS. DO NOT ATTEMPT TO USE DEFORMED, USED, OR SOILED PROJECTILES. PROJECTILES OTHER THAN .43 CALIBER PAINTBALLS OR RUBBERBALLS CAN CAUSE INJURY TO YOU OR SOMEONE ELSE OR MAY DAMAGE AND/OR JAM THE MARKER. USE OF ANYTHING OTHER THAN .43 CALIBER PAINTBALLS OR RUBBERBALLS WILL VOID THE WARRANTY.

4B. Unloading Paintballs or Rubberballs

- Always point the marker in a SAFE DIRECTION.
- Make sure the marker is “ON SAFE” (See **Step 2**).
- Remove the magazine by pressing the magazine release button and pulling the magazine from the bottom of the grip frame.
- Cock the marker by pulling the slide all the way back (**Fig. 5A**).
- Point the marker in a SAFE DIRECTION.
- Put the marker “OFF SAFE” (See **Step 2**).
- Pull the trigger to fire until the marker no longer shoots projectiles.
- Decock your marker by pushing the decocking button or lever. (The RAM Combat and RAM Desert Eagle do not have a decocking mechanism.)
- Put the marker “ON SAFE”.

Note: The marker must be charged with CO₂ when following these steps, but remember, do not store your marker with a CO₂ capsule in it.

5. Aiming and Firing Safely

- You and others within range should always wear eye and ear protection made specifically for paintball to protect your eyes and ears.

- Always aim your marker in a SAFE DIRECTION. When you are sure of your target and backstop, and the area around the target is clear, cock the marker by pulling the slide all the way back and releasing (**Fig. 5A**).
- Take “OFF SAFE” (See **Step 2**) and squeeze the trigger with steady pressure until the marker fires.
- Through the BlowBack System, the marker will be cocked and ready to fire after each pull of the trigger.
- After all projectiles have been fired, the slide will stop in its rearmost position. Repeat loading (See **Step 4A**). After the magazine has been reloaded, press the slide catch down.
- Never aim markers at pets, water, or people not in game play.
- Do not shoot paintballs or rubberballs at hard surfaces or the surface of water. Rubberballs may bounce off or ricochet and hit someone or something you had not intended to hit.
- Always choose your target carefully. Only targets which cannot be penetrated or which will not cause ricochets should be used.
- Your backstop should be checked for wear before and after each use. Replace your backstop if the surface is worn or damaged, or if a ricochet occurs.
- The marker is correctly aimed when the white dot on the front sight blade is positioned exactly in the notch and even with the white dots of the rear sight. The top of the front sight blade should be even with the top of the notch in the rear sight. The bullseye should appear to rest on the top of the front sight (**Fig. 7**).

You can prevent the **RAM X50** marker from unintentional firing even when the slide has been cocked for single action shooting.

To do so, press down the decocking lever **6A**. The hammer position of the airgun marker can be seen at the rear.

- Hammer cocked **6B**.
- Hammer uncocked **6C**.

NOTE: The airgun marker can be fired with hammer decocked by simply pulling the trigger and marker “OFF SAFE”.



Fig. 6A

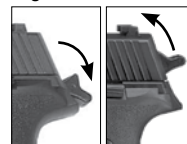

Fig. 6B

Fig. 6C



⚠ CAUTION: KEEP YOUR HAND AWAY FROM THE SLIDE WHILE SHOOTING, THE RELOADING (BLOWBACK) ACTION COULD CAUSE INJURY.

You may fire the RAM X50 in single action or double action mode:
 Single action (with the hammer already cocked): for accurate shots.
 Double action (without the hammer cocked): for rapid shooting.

You may fire the P99 RAM in single action or double action mode:

Single action (with the slide already cocked): for accurate shots.

Double action (without the slide cocked): for rapid shooting.

The RAM Combat shoots in double action only.

The RAM Desert Eagle shoots in single action only.

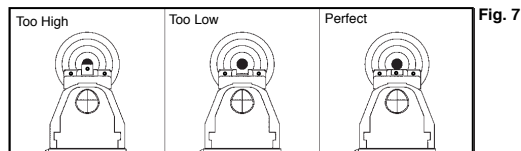

Fig. 7

6. Adjusting the Sights

- Aim at a safe target.
- Line-up the front sight in the middle of the rear sight (Fig. 7)
- Hold the airgun so that the center of the target rests on top of the front sight. The top edge of the front sight and the center of the target should be in a line (Fig. 7).
- The rear sight is laterally adjustable (Fig. 8). Push the rear sight to the left if the airgun shoots too far right. Push the rear sight to the right if the airgun shoots too far left.



Fig. 8

7. Use and Handling of CO₂ Capsules

⚠ WARNING: A CO₂ CAPSULE CONTAINS GAS UNDER PRESSURE. WHETHER OR NOT IT HAS BEEN INSERTED INTO A MARKER. IF EXPOSED TO HIGH TEMPERATURES (SUCH AS INSIDE A CLOSED CAR AND/OR IN DIRECT SUNLIGHT, IT COULD EXPLODE. STORE ALL CAPSULES IN A COOL PLACE.

Always follow warnings listed on propellant source for handling and storage.

It is possible that certain conditions may affect a CO₂ capsule, which can impact its proper performance. These conditions include the usage, maintenance and storage at temperatures that are higher or lower than normal outdoors temperatures (59°F/15°C to 69.8°F/21°C). Another condition may be when the marker is fired rapidly.

1. High temperatures can increase pressure in the CO₂ capsule and also within the marker, leading to higher than standard operating pressure. This excess pressure could cause the marker to malfunction or be permanently damaged. Maximum storage or operation temperature should never exceed 122°F (50°C). This temperature can be reached if you leave the marker under direct sunlight on a bright day. Thus, to ensure proper marker operation, do not expose it to high temperatures or direct sunlight for long periods of time. Otherwise, the CO₂ capsule could overheat and explode, which could damage the marker and cause injuries or death to people around it.
2. Fast consecutive shooting may produce a decrease of temperature in the marker, as well as the CO₂ capsule. This could result in lower projectile velocities and may even lower gas pressure enough so that the marker will not fire. This condition can be especially apparent when shooting in cold weather and can be avoided by allowing more time between shots. This permits the gas to increase in temperature and pressure and produce normal velocities.
3. During rapid fire, the muzzle velocity of each shot will diminish. This can affect shooting accuracy and you will get fewer shots per CO₂ capsule.
4. Care should be exercised to ensure that the marker is not shot with a CO₂ capsule that is low in pressure. Here are some indicators of insufficient pressure:
 - A) The sound of the shot is not as loud as when the capsule is full.
 - B) The projectile hits the target, but in a lower position than it would with a full CO₂ capsule (that is, the shooting speed has dropped).

⚠ CAUTION: NEVER ATTEMPT TO REUSE A CO₂ CAPSULE FOR ANY PURPOSE.

⚠ CAUTION: ALWAYS CHECK TO MAKE SURE MARKER IS UNLOADED WHEN GETTING FROM STORAGE OR FROM ANOTHER PERSON.

8. Maintenance and Storage

- Inspect your marker routinely for proper function.
- **IMPORTANT:** When storing the RAM P99 and X50, cock the slide then push the decock button so that the hammer is not against the valve.
- Before you attempt to perform maintenance on your marker, make sure the marker is "ON SAFE" (See Step 2) and unloaded, and the CO₂ cylinder has been removed (See Step 3B).

- Your marker will maintain proper function for a long time if you oil the slide rails with 1 drop of RAM Oil after you have fired approximately 250 shots. DO NOT use a petroleum distillate based oil or solvent and DO NOT over-oil because this can cause damage to your marker.
- Apply 1 to 2 drops of RAM Oil onto all other moving parts such as the projectile follower and threads of the gas capsule holder.
- Clean the surface of your marker with a soft cloth and RAM Oil.
- Only keep and store any marker in its unloaded condition. Make sure there are no projectiles left in the barrel. Remove the CO₂ capsule (See **Step 3B**). Remove any remaining projectiles from the magazine.
- Keep the barrel blocking device on the muzzle when not shooting.
- Store the marker unloaded and with the CO₂ capsule removed in a secure location.
- Store projectiles separate from marker and in a climate controlled area between the temperatures of 59 and 80 degrees Fahrenheit.
- If you drop your marker, check to see that it works properly before you use it again. If anything seems changed, like a shorter or weaker trigger pull, this may mean worn out or broken parts. Call Customer Service at Umarex USA for assistance before using your marker again.

⚠ CAUTION: BEFORE ANY CARE, CLEANING, OR MAINTENANCE, ALWAYS BE SURE YOUR MARKER IS "ON SAFE" AND UNLOADED. IT IS IMPORTANT TO MAINTAIN YOUR MARKER PROPERLY.

Barrel Cleaning for the P99 RAM, RAM X50 and RAM Desert Eagle:

- Always keep your marker pointed in a SAFE DIRECTION and keep your hands away from the front of the muzzle.
- Put the marker "ON SAFE" (See **Step 2**).
- Remove the magazine.
- Make certain there are no projectiles in the marker (See **Step 4B**).
- Get access to the breech by pulling the slide all the way back until it catches on the slide catch.
- Attach the cleaning cloth(a) to the end of the barrel cleaner(b) that was included with your marker (See **Fig. 9A**).
- Push the barrel cleaner through the opening of the breech towards the muzzle (See **Fig. 9B**).
- Pull the barrel cleaner with the cloth attached through the barrel (See **Fig. 9B**).
- Repeat this action until the barrel is clean and free of paint or oil.

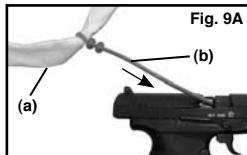

Barrel Cleaning for the RAM Combat:

- Always keep your marker pointed in a SAFE DIRECTION and keep your hands away from the front of the muzzle.
- Put the marker "ON SAFE" (See **Step 2**).
- Remove the magazine.
- Make certain there are no projectiles in the marker (See **Step 4B**).
- Attach the cleaning cloth(a) to the loop end of the flexible cleaning rod(b) that was included with your RAM Combat (See **Fig. 10E**).
- Pull the slide backwards, then allow it to move forwards until the barrel protrudes from the muzzle 1/2-inch continue to hold the slide in this position (See **Fig. 10A and 10B**).
- While holding the slide, push the flexible cleaning rod (angled end first, See **Fig 10C**) through the loading port (**Fig. 10D**) in the magazine well until it exits the muzzle (See **Fig. 10E and 10F**).
- Repeat this action until the barrel is clean and free of oil.

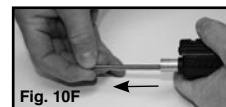
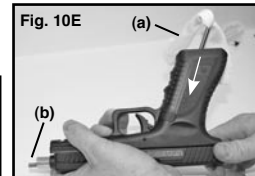
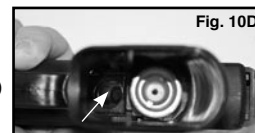

9. Trouble Shooting

Solution / Problem	CO2 Gas Capsule is empty	Barrel is dirty	Incorrect Projectiles
Bad shooting efficiency	●	●	●
Airgun does not function	●		●
Low projectile velocity	●	●	●
CO2 Leaking	Pull the slide back a couple of times and dry fire 3-4 times.		

10. Reviewing Safety

- Every person within range must wear eye, face, and ear protection designed specifically to stop paintballs and meeting specification F 1776.
- Always measure your marker's velocity before playing paintball and never shoot at velocities in excess of 300 feet per second.
- CAUTION: Shooting at velocities in excess of 300 fps may damage your pistol, reduce accuracy, and will void your warranty.
- Never point the airgun marker at anything you do not intend to shoot.
- Always treat the marker as though it is loaded and with the same respect you would a firearm.
- Always aim in a SAFE DIRECTION. Always keep the muzzle of the marker pointed in a SAFE DIRECTION.
- Always keep the marker "ON SAFE" until you are ready to shoot.
- Always check to see if the marker is "ON SAFE" and unloaded when getting it from another person or from storage.
- Always keep your finger off the trigger and out of the trigger guard until ready to shoot.
- Use the proper size projectile for your marker.
- Do not shoot at hard surfaces or at the surface of water. The projectile may bounce off or ricochet and hit someone or something you had not intended to hit.
- Place the backstop in a location that will be safe should the backstop fail.
- Your backstop should be checked for wear before and after each use. All backstops are subject to wear and will eventually fail. Replace your backstop if the surface is worn or damaged or if a ricochet occurs.
- Do not attempt to disassemble or tamper with your marker. Unauthorized repairs or modifying the function of your marker in any way may be unsafe and will void your warranty.
- Before you store your marker, make sure it is unloaded, the CO₂ capsule is removed, and is "ON SAFE."
- Do not shoot at fragile objects such as windows.

⚠ WARNING: A MARKER THAT IS NOT OPERATING PROPERLY MAY BE DANGEROUS. IT SHOULD BE KEPT SAFELY FROM USE BY ANYONE UNTIL REPAIRED OR DESTROYED. DO NOT TRY TO TAKE THE MARKER APART. IT IS DIFFICULT TO REASSEMBLE AND IMPROPER DISASSEMBLY OR REASSEMBLY CAN CAUSE SERIOUS INJURY OR DEATH.

⚠ CAUTION: THE COMPONENTS OF THIS MARKER WERE ENGINEERED AND MANUFACTURED TO DELIVER OPTIMUM PERFORMANCE. ANY MODIFICATION OR TAMPERING WITH A MARKER MAY CAUSE A MALFUNCTION, VOID YOUR WARRANTY, AND MAY MAKE IT UNSAFE TO USE. ANY CHANGE IN PERFORMANCE (SUCH AS A LOWERED TRIGGER PULL FORCE AND SHORTENED TRIGGER TRAVEL) INDICATES POSSIBLE MODIFICATION, TAMPERING AND/OR WEAR. SUCH MARKER SHOULD BE INSPECTED, REPLACED, OR PROPERLY REPAIRED BY ONLY QUALIFIED UMAREX USA PERSONNEL. ANY MARKER THAT HAS BEEN DROPPED SHOULD BE CHECKED BY QUALIFIED PERSONNEL TO ENSURE THAT ITS FUNCTION HAS NOT BEEN AFFECTED.

12. Repair / Service / Warranty

Do not return defective or damaged product to the dealer. If your marker needs repair, call Umarex USA (479) 646-4210 and ask for the Service Department or visit www.umarexusa.com. DO NOT ATTEMPT TO DISASSEMBLE IT! Your marker requires special tools and fixtures to repair it. **Any disassembly or modification not performed by Umarex USA will void the warranty.**

1 YEAR LIMITED WARRANTY

This product is warranted to the retail consumer for one (1) year from date of purchase against defects in material and workmanship and is not transferable. **WHAT IS COVERED:** Replacement parts and labor.

WHAT IS NOT COVERED: Shipping charges to Umarex USA for defective product and damages caused by abuse or failure to perform normal maintenance as well as any other expense. Consequential damages, or incidental expenses, including damage to property. Some states do not allow the exclusion or limitation of incidental or consequential damages, so the above limitation or exclusion may not apply to you.

WARRANTY CLAIMS: Warranty Claims and Repair for U.S. and Canadian customers only. Call Umarex USA (479) 646-4210 and ask for the Service Department. If it is determined a return is necessary, you will be issued a Return Authorization Number. Write this number boldly on the box and return the product prepaid to Umarex USA. Your name, address, phone number, and a note explaining the defect found must be included in the package. A copy of the original purchase receipt must accompany the return. Include a check made to Umarex USA in the amount of \$16.95 to cover shipping and handling.

IMPLIED WARRANTIES

Any implied warranties, including the implied warranties of merchantability and fitness for a particular purpose, are limited in duration to 1 (one) year from date of retail purchase. SOME STATES DO NOT ALLOW LIMITATIONS ON HOW LONG AN IMPLIED WARRANTY LASTS, SO THE ABOVE LIMITATIONS MAY NOT APPLY TO YOU. TO THE EXTENT ANY PROVISION OF THIS WARRANTY IS PROHIBITED BY FEDERAL, STATE, OR MUNICIPAL LAW WHICH CANNOT BE PREEMPTED, IT SHALL NOT BE APPLICABLE. THIS WARRANTY GIVES YOU SPECIFIC LEGAL RIGHTS AND YOU MAY ALSO HAVE OTHER RIGHTS WHICH VARY FROM STATE TO STATE AND COUNTRY TO COUNTRY.

Walther P99 RAM Specifications

Action:	Double/Single	Safety:	Manual & Decocking button
Caliber:	.43	Magazine Capacity:	9 shots
Projectiles:	Paintballs or Rubberballs	Danger Distance:	250 yards
Velocity:	290 feet per second		
Length:	7.28"		
Weight:	1.95 lbs.		

RAM X50 Specifications

Action:	Double/Single	Safety:	Manual & Decocking lever
Caliber:	.43	Magazine Capacity:	9 shots
Projectiles:	Paintballs or Rubberballs	Danger Distance:	250 yards
Velocity:	250 feet per second		
Length:	7.84"		
Weight:	2.1 lbs.		

RAM Combat Specifications

Action:	Double	Safety:	Manual
Caliber:	.43	Magazine Capacity:	8 shots
Projectiles:	Paintballs or Rubberballs	Danger Distance:	250 yards
Velocity:	250 feet per second		
Length:	7.8"		
Weight:	1.7 lbs.		

RAM Desert Eagle Specifications

Action:	Double	Safety:	Manual
Caliber:	.43	Magazine Capacity:	8 shots
Projectiles:	Paintballs or Rubberballs	Danger Distance:	250 yards
Velocity:	270 feet per second		
Length:	10.75"		
Weight:	2.6 lbs.		

UMAREXUSA®

6007 South 29th Street, Fort Smith, Arkansas 72908 USA

Phone: 1-479-646-4210 www.UmarexUSA.com