

HAWKE[®]
SPORT OPTICS

NIGHT VISION

5x40 DIGITAL MONOCULAR



Hawke Sport Optics
Avocet House, Wilford Bridge Road, Melton,
Woodbridge, Suffolk, IP12 1RB, UK

www.hawkeoptics.com
Tel: +44 (0)1394 387762 | Fax: +44 (0)1394 386255

INSTRUCTION MANUAL

CONTENTS



Overview.....	Pg. 3-4
Components.....	Pg. 5-6
Battery installation.....	Pg. 7
Power on/off.....	Pg. 8
Focusing.....	Pg. 9
Screen brightness.....	Pg. 10
Infrared illuminator.....	Pg. 11-12
Photo mode.....	Pg. 13
Video mode.....	Pg.14
Photo playback.....	Pg. 15
Video playback.....	Pg. 16
Date and time.....	Pg. 17
Monitor connection.....	Pg. 18
Computer connection.....	Pg. 18
Battery.....	Pg. 19
Recharging.....	Pg. 19
Specification.....	Pg. 20
Additional information.....	Pg. 21

OVERVIEW



- The Hawke Digi NV Monocular can be used for observation in complete darkness or low light conditions.
- The viewing distance in low light conditions is infinity. Complete darkness restricts the viewing distance to a maximum of 200 metres.



- Quick and easy transfer of data via USB lead, view images and video on a monitor with video OUT and recharge the battery using the DC IN socket.

OVERVIEW



- The monocular can be used to take photos or capture video during the day or at night.
- The Hawke Digi NV monocular is the perfect optical device to enhance your vision at night.
- A built-in infrared illuminator provides additional light when in darker conditions. The infrared strength can be adjusted to suit your situation.
- Up to 1.5 hour runtime without the use of infrared illuminator. Up to 1 hour with IR illuminator on.

COMPONENTS



1. Objective lens cover
2. Objective focus wheel
3. Infrared illuminator
4. 5V DC IN
5. Mini USB 2.0 socket
6. Video OUT
7. Threaded tripod mount
8. Battery compartment
9. Dioptre focus wheel

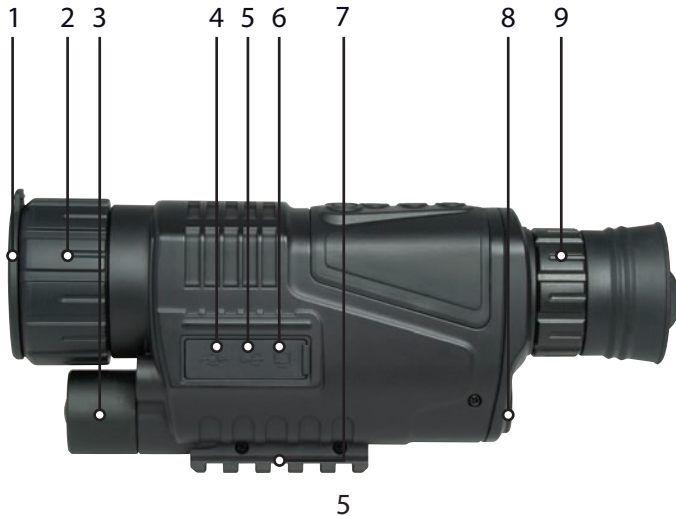

COMPONENTS



- | | |
|-------------------------|-----------------|
| 10. Eyecup | 14. Mode button |
| 11. Dioptre marker | 15. Up button |
| 12. Power/Select button | 16. Down button |
| 13. IR button | 17. Hand strap |



BATTERY INSTALLATION



- Unscrew the battery cover (using a coin in the groove if needed). Insert the battery negative end first and then screw the battery cover back in place.
- Turn the monocular on, the screen will light up if the battery is inserted correctly and is charged.



NOTES:

- Only use 3.7V RCR123A rechargeable batteries.
- Ensure the battery has sufficient charge.
- Ensure battery has been inserted negative end first.

POWER ON



- Remove the objective lens cover.
- Hold the “power” button for 3 seconds to turn the Digi NV Monocular on. Look through the eyecup, it is ready for use when the screen has lit up and the icons are displayed.

DISPLAY ICONS

1. Battery charge indicator
2. Image capacity remaining
3. Current mode (Photo)
4. Storage media (SD card)

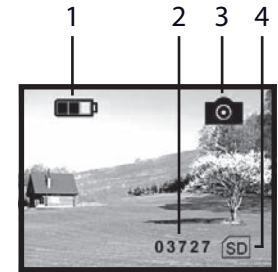

- The monocular will always start in photo mode.

POWER OFF

- In any mode, hold the “power” button for 3 seconds to turn the Digi NV Monocular off.

FOCUSING



- Remove the objective lens cover and look through the eyecup at the screen.
- Adjust the dioptre focus ring until the icons on the screen are sharp.
- Adjust the objective focus wheel until the desired viewing image is sharp.
- The infrared illuminator should be used to achieve the optimum viewing image.
- If the environment is light enough, the infrared illuminator can be turned off to save power.
- Be careful not to block the infrared illuminator, as this will affect the viewing image.

SCREEN BRIGHTNESS



- The brightness adjustment menu allows you to alter the brightness of the digital display.
- While in photo or video mode, press the “IR” button to enter the brightness adjustment menu.

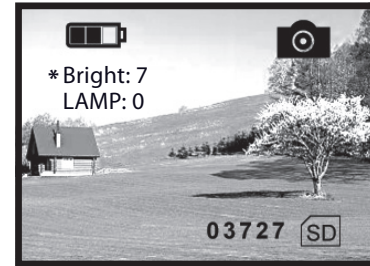

- As shown on the image above, the number after the word “Bright” is the current screen brightness.
- Press the “down” button to reduce the brightness and the “up” button to increase it. There are 9 levels of brightness in total with 9 being the brightest.
- To exit the brightness adjustment menu, press the “IR” button twice.

INFRARED ILLUMINATOR



- The infrared adjustment menu allows you to alter the strength of the assisting infrared light.
- While in photo or video mode, press the “IR” button twice to enter the infrared adjustment menu.

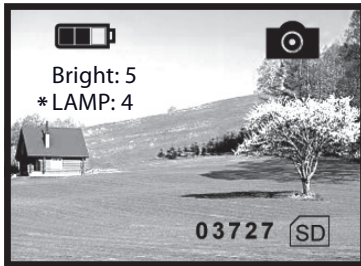

- As shown on the image above, the number after the word “Lamp” is the current infrared strength.
- Press the “down” button to reduce infrared strength and the “up” button to increase it. There are 9 levels of infrared in total with 9 being the strongest.
- To exit the infrared adjustment menu, press the “IR” button.

NOTES:



- In any of the previous adjustment menus, the monocular will return to its current mode if there is no operation within 8 seconds.
- To save battery power, turn the infrared illuminator off when it is not needed by pressing the “down” button until the infrared strength is reduced to 0.

PHOTO MODE



- When the monocular is first operated it will enter photo mode automatically. In this mode you can take still images of your environment.
- If the monocular is not in photo mode, press the “mode” button to cycle through the available modes until you see the photo mode symbol.
- Press the “select” button to capture a still image.
- The photo will automatically save to the internal SD memory card.

DISPLAY ICONS

1. Battery charge indicator
2. Image capacity remaining
3. Photo mode
4. Storage media (SD card)

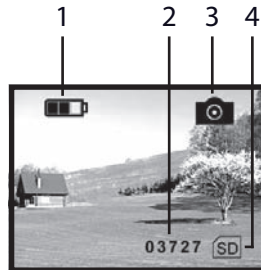

VIDEO MODE



- In photo mode, press the “mode” button twice to enter video mode. In this mode you can record videos of your environment (up to 10 minutes long).
- If the monocular is not in video mode, press the “mode” button to cycle through the available modes until you see the video mode symbol.
- Press the “select” button to start recording video. To end a recording, press the “select” button again.
- The video will automatically save to the internal SD memory card. Video size is based on video length.
- The maximum length of a video is 10 minutes.

DISPLAY ICONS

1. Battery charge indicator
2. Video recording time
3. Video mode
4. Storage media (SD card)

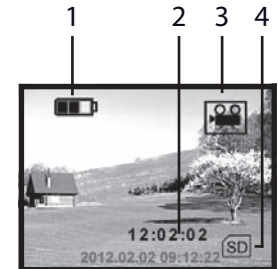

PHOTO PLAYBACK



- In photo mode, press the “mode” button to enter playback mode. This allows you to view any photos or videos you have taken with the monocular.
- If the monocular is not in photo mode, press the “mode” button to cycle through the available modes until you see the playback mode symbol.

DISPLAY ICONS

1. Battery charge indicator
2. Photo serial number
3. Playback mode (Photo)
4. Storage media (SD card)

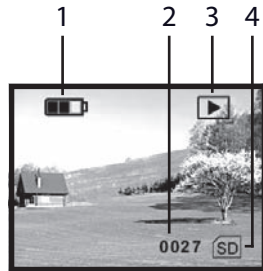

- When in playback mode, use the “down” and “up” buttons to cycle through the photos and videos.

VIDEO PLAYBACK



- In photo mode, press the “mode” button to enter playback mode. This allows you to view any photos or videos you have taken with the monocular.
- If the monocular is not in photo mode, press the “mode” button to cycle through the available modes until you see the playback mode symbol.

DISPLAY ICONS

1. Battery charge indicator
2. Date and time
3. Video recording time
4. Video serial number
5. Playback mode (Video)
6. VGA video format
7. Storage media (SD card)

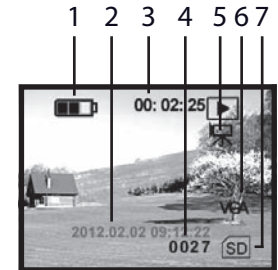

- When in playback mode, use the “down” and “up” buttons to cycle through the photos and videos. Pressing the “select” button will start and stop video playback if it has the video playback symbol.

DATE AND TIME



- Connect the monocular to your computer using the USB lead supplied.
- The computer will identify the monocular automatically and read the content on the SD card.
- Locate and open the “time.txt” file.
- Adjust the date and time in the following format:
yyyy.mm.dd hh.mm.ss
- Save and close the “time.txt” file.
- Copy the “time.txt” file and paste it into the root directory (the top-most folder)
- Eject the monocular and disconnect the USB lead.
- The correct date and time are now set.
- The date and time settings will reset if the battery is fully discharged or removed from the monocular for long periods of time.

MONITOR CONNECTION



- Connect your monitor to the Video OUT on the monocular using the video lead supplied.
- Hold the “power” button for 3 seconds, the monitor will now display the screen of the monocular.

COMPUTER CONNECTION

- Connect the monocular to your computer using the USB lead supplied.
- The computer will identify the monocular automatically and read the content on the SD card.
- The battery will be charged while the monocular is connected to the computer.

AUTO POWER OFF

- After 3 minutes of no operation the monocular will turn off (except in video or playback mode).

BATTERY



- RCR123A rechargeable (650mAh, 3.7V)
- Please ensure the battery is charged for 10 hours before first use to increase life expectancy.

RECHARGING

- Connect the power adaptor to the 5V DC IN.
- The LED charging indicator next to the 5V DC IN will glow red while the battery is charging and turn off when it is fully charged.
- The LED will not glow red when charging on a computer via the USB lead. The charge indicator on the monocular display can be used to determine when it is fully charged.

SPECIFICATION



Magnification:	5x
Objective diameter:	40mm
Field of view:	5° x 3.75°
Ocular adjustment:	+/- 0.6
Range (low light):	2m - ∞
Range (dark):	2m - 200m
Voltage:	3.7V DC
Battery:	RCR123A rechargeable
Charger:	5.0V/2A Adaptor
Dimensions:	200 x 86 x 56mm
Weight:	400g

SUPPLIED WITH:

Video lead, USB lead, power adaptor, carry case, lens cloth, 2x batteries, hand strap and instruction manual.



ADDITIONAL INFORMATION

- Keep monocular in its carry case when not in use.
- Operating temperature: -5°C to 40°C.
- Store in a cool dry environment.
- If the monocular image jitters or the screen does not light up, recharge the battery.
- Blow away any dust from the lens before wiping.
- Inspect the battery regularly for any signs of degradation and replace if necessary.
- If the monocular is not in use for long periods of time, recharge the battery every 6 months.