



AR20
AR20^{ft}
Air rifle
cal. .177 (4.5 mm)

USA

READ THIS OWNER'S MANUAL COMPLETELY.
This airgun is not a toy. Treat it with the same respect you would a firearm.
Always carefully follow the safety instructions found in this owner's manual
and keep this manual in a safe place for future use.

EN Operating instructions 2 - 12

WARNING: NOT A TOY. THIS AIRGUN IS DESIGNED FOR USE BY EXPERIENCED SHOOTERS 18 YEARS OF AGE OR OLDER AND IS INTENDED FOR MATCH COMPETITION OR TARGET RANGE USE. THIS GUN DOES NOT HAVE A MECHANICAL SAFETY DEVICE. MISUSE OR CARELESS USE MAY RESULT IN SERIOUS INJURY OR DEATH. DANGEROUS WITHIN 500 YARDS (457 METERS).



Safety instructions



Care



Designation of Parts



Operation

Learn how to handle your gun in a safe and proper manner.

- Always keep the muzzle pointed in a safe direction.
- Always handle any gun as if it were loaded.
- Always keep your finger off the trigger and out of the trigger guard until ready to shoot.
- Only use the kind of projectiles specified for your gun.
- Never transport a loaded gun. Only load your gun when you intend to fire it.
- Avoid ricochets. Never fire at smooth, hard surfaces or water.
- Before you discharge your gun, make sure that the target and surrounding area are safe.
- Make sure that you always have full control over the muzzle of your gun, even if you stumble or fall down.
- Safety shooting glasses should always be worn when firing any gun. Shooting glasses must be worn over normal reading glasses.
- Always store your gun in a safe place and in unloaded condition. Unauthorized persons (persons not familiar with the use of guns, children and minors) must not have access to it, ammunition is to be kept in a separate place.
- The gun together with its operating instructions may only be handed over to persons who have reached legal age according to the laws and ordinances governing you and who are fully familiar with the handling of it.
- Modifications or repairs of guns should only be performed by an authorized Umarex USA gunsmith.
- Never leave a loaded gun unattended.
- Only unloaded guns are to be handed over to another person.
- Make sure the gun is unloaded when getting it from storage or from another person.
- Never point the airgun at anything you do not intend to shoot.
- Replace the backstop if it becomes worn. Place the backstop in a location that will be safe should the backstop fail.



SAFETY INSTRUCTIONS



CARE

EN

WARNING:

THIS AIR RIFLE CAN CAUSE SERIOUS INJURY OR DEATH. READ AND FOLLOW THE INSTRUCTIONS CAREFULLY. DO NOT LOAD A PROJECTILE INTO THE AIR RIFLE UNTIL YOU ARE READY TO SHOOT. IF YOU DO LOAD A PROJECTILE AND THEN DECIDE NOT TO SHOOT, REMOVE IT EITHER MANUALLY OR BY SHOOTING THE AIRGUN AT A SAFE TARGET. ACCIDENTS HAPPEN FAST, PLEASE HANDLE THE AIRGUN SAFELY.



CAUTION

Always check to make sure that the air rifle is unloaded when getting from storage or from another person.



CAUTION

You and others with you should always wear shooting glasses to protect your eyes. Read all instructions before using.



CAUTION

Failure to follow the instructions and recommendations in this owner's manual may result in bodily injury including face, eye, and ear injury, blindness, or deafness.

WARNING:

INSTRUCTIONS FOR AR20 AND AR20^{FT} AIR RIFLE

THE GUN REMAINS UNDER PRESSURE EVEN AFTER REMOVAL OF THE COMPRESSED AIR CYLINDER. THE AIR USED MUST COMPLY WITH DIN 3188 (BREATHING AIR). DO NOT STORE COMPRESSED AIR CYLINDERS AT TEMPERATURES ABOVE 48.9°C (120°F). ALWAYS ADHERE TO THE WARNINGS AND SAFETY INSTRUCTIONS OF THE MANUFACTURER CONCERNING THE HANDLING AND STORAGE OF COMPRESSED AIR CYLINDERS.



CAUTION

For your own safety and the safety of others, carefully read these instructions before using this airgun. Buyers and owners must observe all rules concerning the use and ownership of air guns. Modifying this airgun may result in a change of its classification under certain gun laws and is therefore prohibited. In such cases the manufacturer's warranty will immediately become void.



WARNING:

COMPRESSED AIR CYLINDER MAY EXPLODE AT TEMPERATURES ABOVE 48.9°C (120° F). DO NOT MUTILATE OR INCINERATE THEM. DO NOT EXPOSE THEM TO HEAT OR STORE COMPRESSED AIR CYLINDER AT TEMPERATURES ABOVE 48.9°C (120°F).



WARNING:

AN AIR RIFLE THAT IS NOT OPERATING PROPERLY MAY BE DANGEROUS. IT SHOULD BE KEPT SAFELY FROM USE BY ANYONE UNTIL REPAIRED OR DESTROYED. DO NOT TRY TO TAKE THE AIRGUN APART. IT IS DIFFICULT TO REASSEMBLE AND WILL VOID THE WARRANTY.

CARE

Clean the external metal parts with a soft cloth that has been moistened with gun oil. Perform routine inspections of your airgun.



CAUTION

Before any care, cleaning or maintenance, always be sure your air rifle is unloaded. Keep pointed in a safe direction. It is important to perform routine inspections and maintain your air rifle properly.



CAUTION

Oils that contain acid or resin can damage the seals and possibly the air rifle finish.





SAFETY INSTRUCTIONS



TECHNICAL DATA



EN

REPAIR

Do not attempt to repair this air rifle if it needs service. Incorrect assembly could lead to dangerous malfunctions.



CAUTION

Repairs should only be completed by an Umarex USA authorized gunsmith.



CAUTION

The components of this airgun were engineered and manufactured to deliver optimum performance. Any modification or tampering with an airgun may cause a malfunction, void your warranty and may make it unsafe to use. Any change in performance (such as a lowered trigger pull force and shortened trigger travel) indicates possible modification, tampering and/or wear. Such air rifle should be inspected, replaced, or properly repaired by only qualified Umarex USA personnel. Any air rifle that has been dropped should be checked by qualified personnel to ensure that its function has not been affected.

PROBLEMS

Problems	Possible causes					
	Cylinder is empty	Dirt in barrel	Cylinder not correctly screwed on	Wrong ammunition	Ammunition not properly loaded	Trigger not properly adjusted
Poor shooting performance	●	●		●	●	
Gun does not shoot	●		●	●		●
Slow projectile	●	●		●	●	

4

AR20 Air Rifle

Energy	7.5 J
System	Compressed air 300 + 200 bar
Caliber	.177 (4.5 mm)
Overall length	min. 41.7 ins (1058 mm) - max. 43.7 ins (1109 mm)
Sight length	31.5 in. (800 mm)
Barrel length	19.7 in. (500 mm)
Weight (with cylinder)	9.45 lbs (4286 g)
Muzzle velocity	560 fps (171 m/s)
Propellant	Aluminum compressed air cylinder

AR20[®] Air Rifle

Energy	10.5 J
System	Compressed air 300 + 200 bar
Caliber	.177 (4.5 mm)
Overall length	min. 37.7 in. (958 mm) - max. 39.7 in. (1009 mm)
Barrel length	19.7 in. (500 mm)
Weight (with cylinder)	12.4 lbs (5630 g)
Muzzle velocity	780 fps (238 m/s)
Propellant	steel compressed air cylinder



DESIGNATION OF PARTS

EN

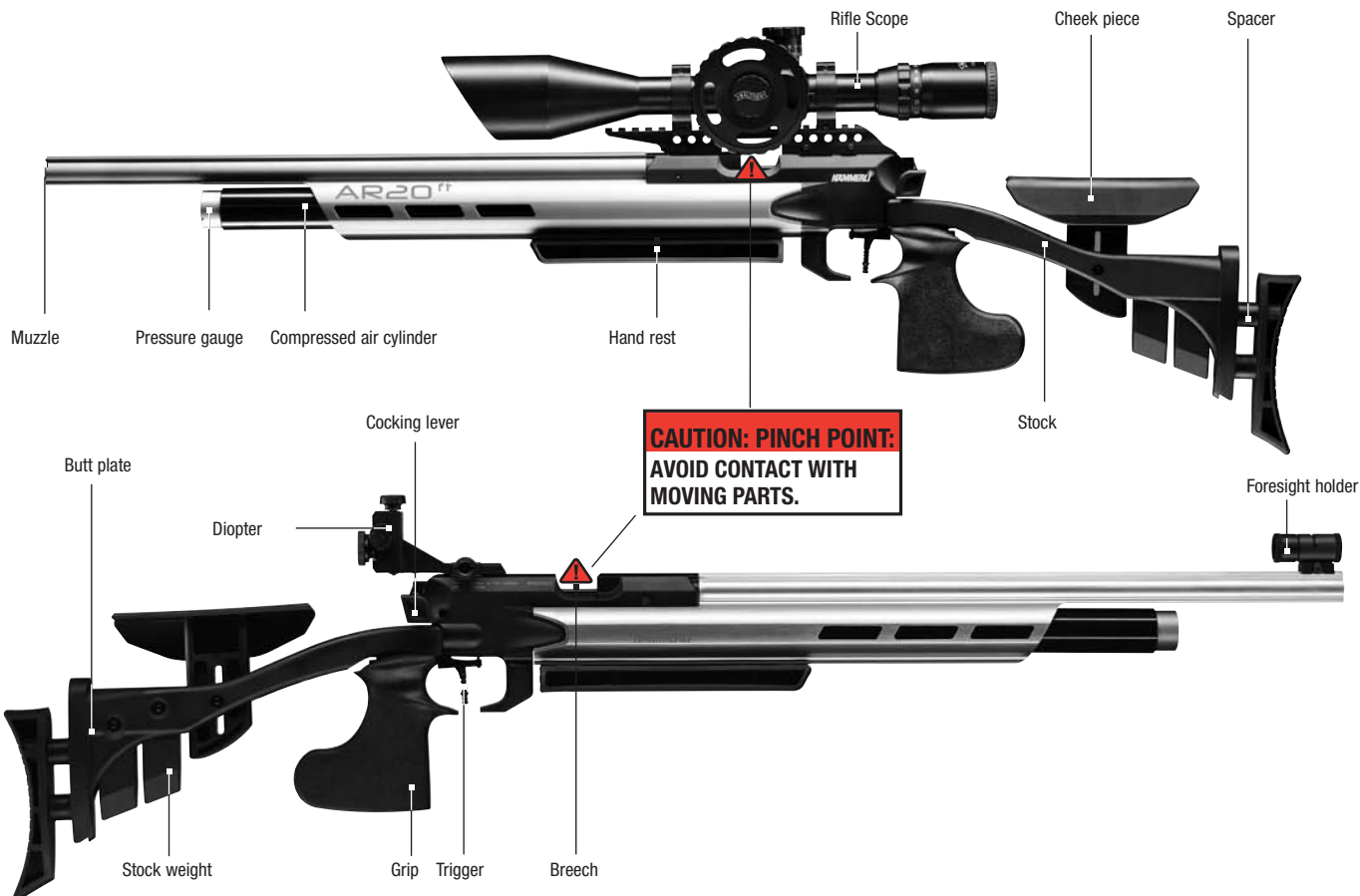



HANDLING THE COMPRESSED AIR CYLINDER

EN

Note: To ensure that your gun works properly, please use only Walther accessories.

Insert the compressed air cylinder into the fore-end with the opening first and screw it tight (clockwise). The rifle is now under pressure. To test whether the cylinder has been screwed in correctly, make sure the gun is not loaded and shoot in a safe direction. If the gun doesn't fire, check the items under "Problems".



CAUTION

The airgun remains under pressure even after removal of the compressed air cylinder.



CAUTION

To release all the pressure, unscrew the compressed air cylinder and shoot in a safe direction until the gun can no longer fire.



CAUTION

When you pierce a compressed air cylinder, make sure that the barrel is pointing in a safe direction.



6

Filling procedure

The compressed air cylinder can be refilled at any time, even if it is not yet empty. When filling, observe the provisions of the TRG (technical regulations relating to pressurized gas). The maximum permissible filling pressure of 300 bars must not be exceeded under any circumstances. Observe applicable national statutory regulations for refilling. Cylinders which are leaky, have expired or are otherwise unsafe must not be refilled. Empty them in a safe manner. Screw the adapter onto the refill cylinder and tighten it. Then screw the compressed air cylinder onto the adapter and tighten it securely. Open the cylinder valve for approx. 5 seconds and then close it. Remove the cylinder and screw it back onto the gun. Compressed air cylinders must never be used or stored above maximum pressure.

Instructions on the use of compressed air cylinders

Compressed air cylinders which are leaky, damaged or more than 10 years old should be emptied in a safe manner and not used or filled again. Ten years after the manufacturing date, the compressed air cylinder must be tested at the owner's expense or replaced. The manufacturing date is recorded on the cylinder.



CAUTION

The air used must comply with DIN 3188 (breathing air).



CAUTION

Never try to use force when inserting a compressed air cylinder.



CAUTION

Do not store compressed air cylinders at temperatures above 48.9°C (120°F).



LOADING THE RIFLE

EN

CAUTION

Always make sure that the muzzle points in a safe direction.

WARNING:

BE SURE THE AIRGUN IS ALWAYS POINTED IN A SAFE DIRECTION. NEVER POINT THE AIRGUN AT ANY PET OR PERSON EVEN IF IT IS UNLOADED. ALWAYS ASSUME AND HANDLE THE AIRGUN AS IF IT WERE LOADED AND READY TO FIRE.

CAUTION

Use only .177 caliber (4.5 mm) pellets. Do not attempt to reuse pellets that have been fired or are deformed. Do not use buck shot, darts, ball bearings, or other foreign objects because they can cause injury to you or someone else or may damage and/or jam the airgun.



Loading

- 1 Release the cocking lever.
- 2 Pull back the cocking lever. The cocking piece is now cocked. The breech is freed.

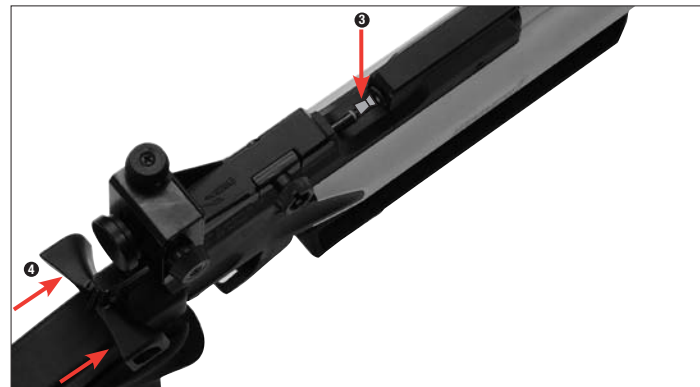

- 3 Place a pellet in the breech. Observe correct position!
- 4 Push the cocking lever forward until it clicks into place.



ADJUSTING THE TRIGGER

EN



CAUTION

Before performing any adjustment, assembly, care or cleaning work, keep the gun pointed in a safe direction, and always check the gun to be sure it is unloaded, the air cylinder is removed, and the barrel is free of pellets and foreign matter. Always wear protective eyewear.

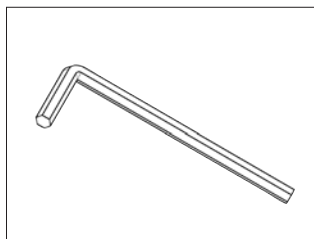
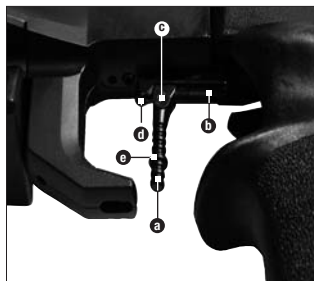

- a** 2.0 mm
- b** 1.5 mm
- c** 1.5 mm
- d** 1.5 mm
- e** 2.5 mm



WARNING:

THE TRIGGER FORCE IS CAPABLE OF ADJUSTMENT BELOW 3-LB AND WHEN ADJUSTED BELOW 3 LB. THE GUN COULD FIRE WHEN DROPPED.

TRIGGER FINGER PIECE

The trigger finger piece **a** can be individually adjusted according to the shooter's trigger finger. After the screw **b** has been loosened, the trigger finger piece can be pushed forward or pulled back on the guide **c** and can also be pivoted sideways. The height adjustment is made by moving the O-ring **d**. Another O-ring can be additionally mounted. The trigger finger piece is designed so that it can be used by both left-handed and right-handed marksmen. By fully removing the trigger finger piece and turning it by 180°, the length adjustment area can be extended in one direction.

TRIGGER PRESSURE POINT

The pressure point is set at the factory to the optimal setting. If a correction is required, then by turning the screw **e** to the right (clockwise), you can achieve a dry, direct trigger pressure point. Turning the screw to the left (counterclockwise) sets a "sluggish" pressure point. To shoot with trigger slack, avoid turning the screw too far to the right as this will neutralize the pressure point and it can no longer be felt and the hammer will no longer engage in the loading procedure.

TRIGGER WEIGHT

The trigger pull weight can be individually adjusted without intervals. The trigger pull weight is increased by turning the screw **f** to the right (clockwise). Turning the screw to the left (counterclockwise) produces a lower trigger pull weight.

TRIGGER STOP

A trigger stop can be set by turning the screw **g** to the right (clockwise). The trigger stop is disabled by turning the screw to the left (counterclockwise).

TRIGGER SLACK

The trigger slack, i.e. the path of the trigger finger piece **h** up to the pressure point, can be individually adjusted. The trigger slack is reduced by turning the screw **i** on the trigger finger piece to the right (clockwise). Turning the screw to the left (counterclockwise) produces a lower trigger slack.

DIRECT TRIGGER

To set the trigger to "direct", that is without trigger slack, the screw **j** is turned at least two rotations further to the left (counterclockwise) than described above for an optimal pressure point. That is, the screw no longer contacts. The pressure point can now be set as described above with the screw **d** on the trigger holder **b**.



JAM

CAUTION

Shooting with insufficient pressure can cause a pellet to lodge in the barrel.

Insert filled compressed air cylinder. Close cocking lever and shoot without a pellet. The blocked pellet will fire. If this procedure fails to resolve the problem, remove air cylinder and fire the gun in a SAFE direction until it is empty of air, then push the pellet out backwards using a cleaning rod.

CAUTION

Never look down the muzzle of a gun.



CAUTION

When removing any pellet from the barrel with a cleaning rod, place the rifle horizontally. Do not hold the air Rifle in a vertical position, as the pellet could fall into the mechanism and cause damage.

WARNING: NEVER ASSUME THAT BECAUSE THE AIR RIFLE NO LONGER FIRES A PROJECTILE THAT A PROJECTILE IS NOT LODGED IN THE BARREL. ALWAYS TREAT THE AIR RIFLE AS THOUGH IT IS LOADED AND WITH THE SAME RESPECT YOU WOULD A FIREARM.



ADJUSTING THE SIGHT

EN

Push the diopter on the dovetail rail and tighten hand-tight at the required eye base with the knurled screw.

Height and lateral adjusting screw

Adjustments are made using the two adjusting knobs. The impact point is adjusted by 0.5 mm at 10 m distance per click.

Adjustment ranges

Height adjustment 100 mm, lateral adjustment 80 mm. Excessive turning when making adjustments will impair the function.

Turning direction

Elevation adjustment = when firing high, turn clockwise
= when firing low, turn counterclockwise

Windage adjustment = when firing to the right, turn clockwise
= when firing to the left, turn counterclockwise





STOCK ADJUSTMENT

EN



CAUTION

The specifications of the ISSF sports ordinance must be observed with all settings on the stock.

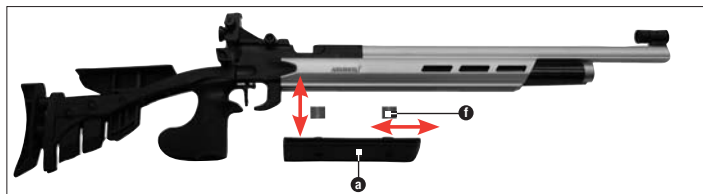
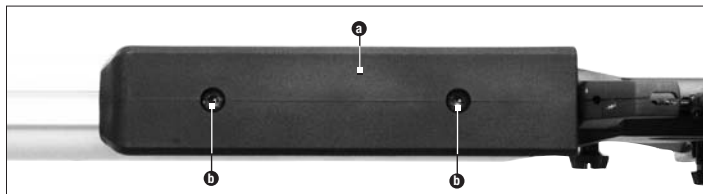

HAND REST

Adjust the hand rest **a** lengthways by loosening the two screws **b**. You can use spacers **f** to adjust the height of the hand rest.



GRIP

The grip can be turned on its own axis by loosening the screw. The grip can be used by both left-handed and right-handed shooters.

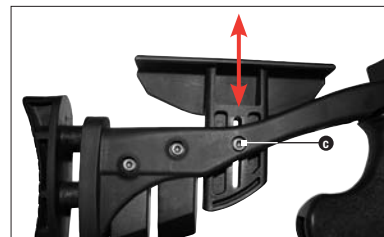

CHEEK PIECE

Loosen screw **c** to adjust the height of the cheek piece. The cheek piece can be used by both left-handed and right-handed shooters. To switch it, loosen screw **c** all the way, remove the cheek piece, turn it by 180°, put it back in and tighten the screw.

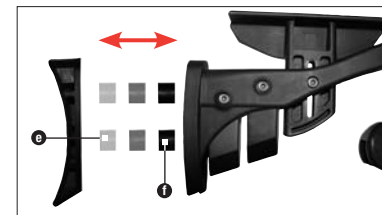
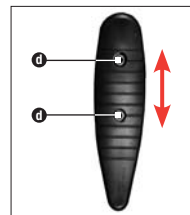

BUTT PLATE

Loosen screws **d**, adjust the height of the butt plate **e** and retighten the screws. Use the spacers **f** to adjust the length of the stock. (Extra screws included for additional spacers.)

STOCK WEIGHTS

Insert the required number of stock weights **g** into the stock and secure them in place with screw **h**. (A stock weight weighs approx. 200 g / .44 lbs.).

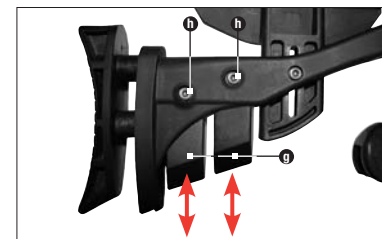

MADE IN GERMANY



Carl WALTHER GmbH - Sportwaffen

WARNING:

DO NOT BRANDISH OR DISPLAY THIS AIRGUN IN PUBLIC – IT MAY CONFUSE PEOPLE AND MAY BE A CRIME. POLICE AND OTHERS MAY THINK IT IS A FIREARM. DO NOT CHANGE THE COLORATION AND MARKINGS TO MAKE IT LOOK MORE LIKE A FIREARM. THAT IS DANGEROUS AND MAY BE A CRIME.

AR20 Air Rifle

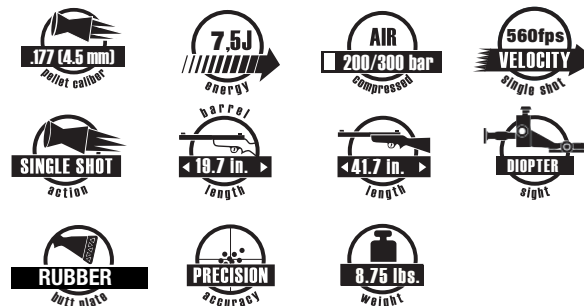

AR20[®] Air Rifle

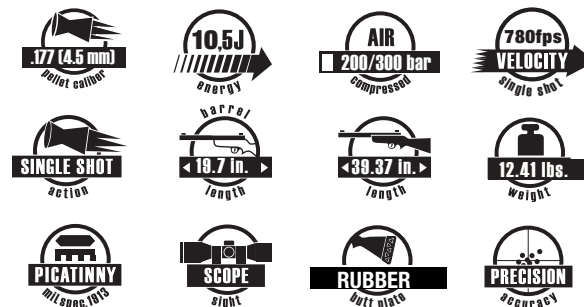

We reserve the right to make color and design changes and technical improvements. No responsibility is accepted for printing errors or incorrect information.

Sous réserve de modifications de couleur et de design, de modifications techniques, d'erreurs d'impression et d'erreurs en général. Informations sous toutes réserves.

Sujeto a cambios de color y diseño así como a mejoras técnicas y errores de impresión. Todos los datos sin garantía.

© UMAREX Sportwaffen GmbH & Co. KG

Distributed by / Distribué par:
UMAREXUSA[®]

www.UmarexUSA.com

7700 Chad Colley Boulevard
Fort Smith, AR 72916
Phone: 479-646-4210

8.466.90.02 | 10/2012