

# Instruction Manual



***PT-85 Blowback Socom***



***P25 Blowback Tactical***



***PT-85 Blowback Tactical***

**READ THIS INSTRUCTION MANUAL COMPLETELY.**

**This airgun is not a toy. Treat it with the same respect you would a firearm. Always carefully follow the safety directions found in this instruction manual and keep this manual in a safe place for future use.**

** WARNING NOT A TOY. ADULT SUPERVISION REQUIRED. MISUSE OR CARELESS USE MAY CAUSE SERIOUS INJURY OR DEATH. MAY BE DANGEROUS UP TO 224 YARDS (205 METERS).**

**This is a high powered airgun intended for use by those 16 years of age or older. Read all instructions before using. The purchaser and user should conform to all laws governing use and ownership of airguns.**

** WARNING LEAD AIRGUN AMMUNITION CONTAINS A CHEMICAL KNOWN TO THE STATE OF CALIFORNIA TO CAUSE CANCER AND BIRTH DEFECTS (OR OTHER REPRODUCTIVE HARM). DO NOT INHALE DUST OR PUT PELLETS IN MOUTH. WASH HANDS AFTER HANDLING.**

**SAFETY RULES:**

- Do not install a magazine which contains ammunition into the gun until you are ready to shoot. If you do install a magazine which contains ammunition into the gun and then decide not to shoot, either manually remove the magazine from the gun or shoot the remaining ammunition at a safe target.

- An unloaded, non-pressurized gun with an “ACTIVATED” safety is safest.
- Accidents happen fast, and accidentally injuring or killing someone is a terrible thing. Please shoot safety.
- Whenever you handle a GAMO pistol, make sure the safety is “ACTIVATED” and there is no ammunition in the magazine.
- Always use eye protection.
- Always use hearing protection.
- Think first, shoot second.
- Always point the gun in a safe direction. Never point your air pistol at people or animals even if it is not loaded.
- Always keep your fingers away from the trigger until you are ready to shoot.
- Always be certain of what is behind your target. Make sure your target does not conceal a person or some object which could be harmed by the pellets.
- Do not shoot at targets which allow ricochets or deflections.
- Do not shoot into or at water.
- Never use drugs or alcohol while handling this product.
- The air pistol and pellets should be kept in separate and secured places.
- Do not walk, run, jump or climb when carrying a loaded air pistol. A loaded air pistol should never be carried inside a vehicle.
- Never modify or alter your GAMO air pistol. Modification of the pistol may cause it to malfunction and tampering with the gun may make it unsafe.

**⚠️ WARNING** DO NOT BRANDISH OR DISPLAY THIS AIRGUN IN PUBLIC. IT MAY CONFUSE PEOPLE AND MAY BE A CRIME. POLICE AND OTHERS MAY THINK THIS AIRGUN IS A FIREARM. DO NOT CHANGE THE COLORATION AND MARKINGS TO MAKE IT LOOK MORE LIKE A FIREARM. THAT IS DANGEROUS AND MAY BE A CRIME.

---

---

## DESCRIPTION:

### P-25 Blowback Tactical



## DESCRIPTION:

- |              |                    |                             |                         |
|--------------|--------------------|-----------------------------|-------------------------|
| 1. Safety    | 4. Rear Sight      | 7. Magazine Release Button  | 10. 20MM RGB Dot Sight  |
| 2. Slide     | 5. CO2 Compartment | 8. Trigger                  | 11. Tactical Flashlight |
| 3. Quad Rail | 6. Magazine Slot   | 9. Muzzle Blast Compensator |                         |

## DESCRIPTION:

### PT-85 Blowback Tactical

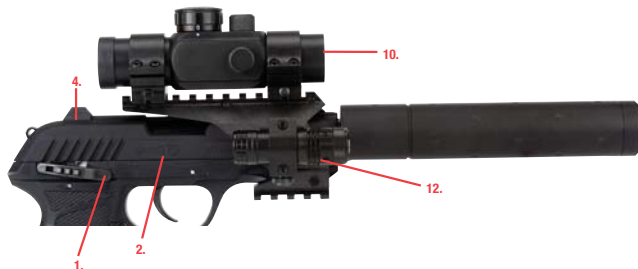

## DESCRIPTION:

- |              |                    |                             |                         |
|--------------|--------------------|-----------------------------|-------------------------|
| 1. Safety    | 4. Rear Sight      | 7. Magazine Release Button  | 10. 13MM RGB Dot Sight  |
| 2. Slide     | 5. CO2 Compartment | 8. Trigger                  | 11. Tactical Flashlight |
| 3. Quad Rail | 6. Magazine Slot   | 9. Muzzle Blast Compensator | 12. Laser Sight         |

---

---

## SAFETY:



**SAFE**

- Activated Safety



**FIRE**

- Deactivated Safety

---

---

## REPLACING THE CO2 BOTTLE:

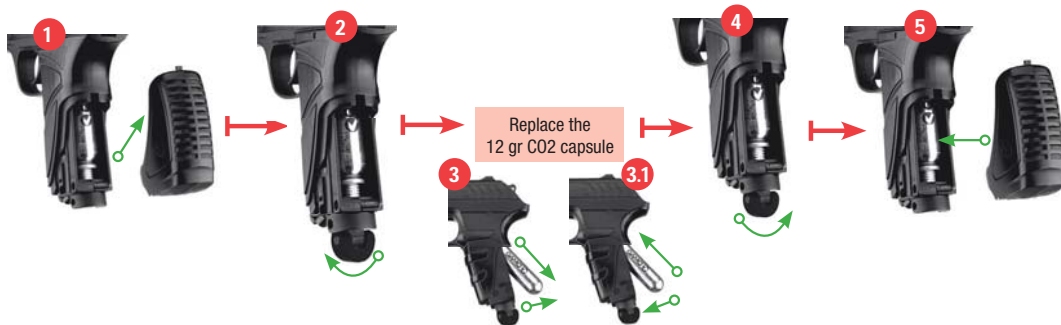

**⚠️WARNING** Use only 12 gram CO2 cylinders. Any attempt to use others types of gas cylinders could be extremely dangerous and could result in serious injury or death. Gases other than CO2 could result in an explosion or rupture the airgun.

**⚠️WARNING** Keep hands and face away from the CO2 cylinder. Escaping CO2 gas can cause frostbite if allowed to come in contact with skin.

---

---

**⚠️WARNING**

**If you are not going to use the pistol for a long period of time, we recommend removing the CO2 bottle.**

**When replacing the CO2 bottle, it is possible that some residual gas is left. In order to avoid accidents, make sure that the pistol is unloaded and the safety is "ACTIVATED" when removing or placing a CO2 bottle. Never use force to insert a CO2 bottle.**

**Keep the CO2 bottles away from heat and flames. Temperatures over 50° C (120° F) can cause explosion and injury. Never throw a CO2 bottle into a fire.**

**Always wear eye protection when handling CO2 bottles, since there is a risk of injury to the eyes. Do not remove a CO2 bottle until it is completely empty. Failure to observe this recommendation can result in a dangerous escape of residual gas.**

---

---

## LOADING THE PELLETS:





---

---

**⚠ WARNING** When preparing to store the pistol, point the barrel at the ground and make sure that the magazine is empty and that there are no pellets in the barrel. In this way you will avoid possible accidents when using the pistol again.

**⚠ WARNING** When there is an obstruction in the barrel, never shoot another pellet. Always make sure that the Safety is activated before clearing an obstruction.

**NOTE:** Always discard defective ammunition. We recommend GAMO ammunition for GAMO CO2 pistols. Never reuse pellets

---

---

## UNLOADING THE PELLETS:

Keep the air pistol pointed in a SAFE DIRECTION. Remove the magazine. Fire at a SAFE target. Repeat until you are sure the air pistol no longer fires ammunition. You may also unload your air pistol by following the directions listed under “Removing Jammed Ammunition”.

---

---

## REMOVING JAMMED AMMUNITION:

Keep the air pistol pointed in a safe direction. Remove the magazine. Remove the CO2 cylinder. Insert a .177 caliber ramrod into the muzzle end and carefully push the jammed BB or pellet into the breech area and remove. If you are not able to unjam your air pistol, take no further action. Call GAMO at (954) 581-5822 and ask for the customer service department. **NOTE:** The barrel could be damaged and the warranty will be void if the proper sized ramrod is NOT used.

**⚠ CAUTION** Make sure that the Safety is activated and the CO2 bottle has been removed before proceeding with the removal of ammunition. Before removing the CO2 bottle, make sure that it is empty of CO2.

---

---

**AIMING SAFELY:**



**Red Dot**



**Green Dot**



**Blue Dot**

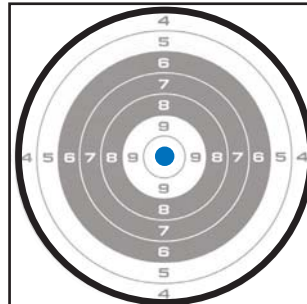

---

---

**FIRING SAFELY:**



---

---

## **USE AND HANDLING OF CO2 CYLINDERS:**

It is possible that certain conditions may affect a CO2 cylinder, which can impact its proper performance. These conditions include the usage, maintenance and storage at temperatures that are higher or lower than normal outdoor temperatures (59°F/15°C to 69.8°F/21°C). Another condition may be when the gun is fired rapidly.

1. High temperatures can increase pressure in the CO2 cylinder and also within the gun, leading to higher than standard operating pressure. This excess pressure could cause the gun to malfunction or be permanently damaged. Maximum storage or operation temperature should never exceed 122°F (50°C). This temperature can be reached if you leave the gun under direct sunlight on a bright day. Thus, to ensure proper gun operation, do not expose it to high temperatures or direct sunlight for long periods of time. Otherwise, the CO2 cylinder could overheat and explode, which may could damage the airgun and cause injuries or death to people around it.
2. Fast consecutive shooting may produce a decrease of temperature in the gun, as well as the CO2 cylinder. This could result in lower projectile velocities and may even lower gas pressure enough so that the pistol will not fire. This condition can be especially apparent when shooting in cold weather and can be avoided by allowing more time between shots. This permits the gas to increase in temperature and pressure and produce normal velocities.
3. During rapid fire, the muzzle velocity of each shot will diminish. This can affect shooting accuracy and you will get fewer shots per CO2 cylinder.
4. Care should be exercised to insure that the gun is not shot with a CO2 Cylinder that is low in pressure. Here are some indicators of insufficient pressure:
  - A) The sound of the shot is not as loud as when the cylinder is full.
  - B) The projectile hits the target, but in a lower position than it would with a full CO2 cylinder (That is, the shooting speed has dropped).

---

---

**STORAGE:**

- Before storing the airgun, make sure the safety is “ACTIVATED”, airgun is unloaded, and the CO2 is removed.
- CO2 pistols should be stored in such a manner as to protect against unauthorized use by children and others.
- These products are designed to look, handle and function like pistols. These products should be stored in such a manner to protect against theft and subsequent misuse.

---

---

**ACCESSORIES:**

***A. Red, Blue, Green Illuminated Center Dot Sight***

***B. Tactical Flashlight***

***C. Laser Sight***

***D. Spare Magazine***

## A. Red, Green, Blue Dot Illuminated Sights

### PT-85 Blowback Sight (62120RD20RGBLS)

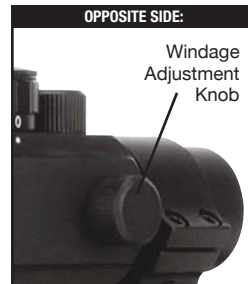

## P-25 Blowback Sight (62120RD20RGB)



**CAUTION**

DIRECT VIEWING OF THE SUN CAN CAUSE PERMANENT EYE DAMAGE. DO NOT ATTEMPT TO VIEW THE SUN WITH EITHER THIS PRODUCT OR THE NAKED EYE.

NOTE: KEEP ALL INSTRUCTIONS FOR FUTURE REFERENCE.

**1. RETICLES**

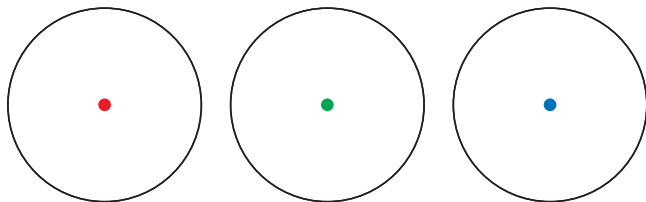

RGB™ Standard 5 MOA Center Dot Reticle: Red, Green, & Blue

**CAUTION**

THE OBJECTIVE LENS (FRONT) OF THE RED DOT SIGHT IS ANGLED. IT IS ANGLED FOR THE PROPER OPERATION OF THE RED DOT.



With settings from 1 to 3, use setting 1 at lowest light, 2 cloudy or overcast and 3 for brightest conditions. On scopes with Red, Green and Blue dots use the color that shows up the best against the background you are looking at, and set the brightness to match the light conditions.

- Remove the battery compartment cap by turning it counter-clockwise.
- Insert the battery with the positive (+) side facing up. (CR2032 3V)
- Replace the cap by turning it clockwise and tighten to avoid moisture or water from getting inside.
- The illuminated feature is activated by turning the rheostat switch to number 1. Each click will increase the intensity, 11 being the maximum.
- To turn the illuminated reticle off, turn the knob to the zero position.

## 2. FUNDAMENTALS OF AN ILLUMINATED SIGHT

Six Basic Elements Form The System Of An Illuminated Sight:

### I. Objective Lens:

Lens responsible for the amount of light that gets inside the scope. In illuminated sights, the objective lens is angled, this is not a defect. It is angled for the proper operation of the sight.

### II. Image System:

A small metal tube with a 50% to 70% transmission mirror, set in a 15 degree slanted angle.

### III. Windage and Elevation System:

The image system tube is fixed at one end and free at the other closest to the objective lens, the windage and elevation screws serve as supports for this end while providing movement or correction to the reticle to adjust the aiming point to the real point of impact of the bullet.

### IV. Reticle:

The reticle replaces the iron sight system that usually comes with rifles. In the case of Illuminated Sights the reticle is a projection of light forming one or more reticles in one or more colors, depending on the reticle design.

### V. Ocular Lens:

The ocular lens seals the end of the sight closest to the eye, responsible for the final collimation of the image.

### VI. Rheostat Switch:

Next to the on/off function, it regulates the intensity of the LED diode.

## 3. MOUNTING THE SIGHT

**⚠ CAUTION** BE SURE THAT THE PISTOL IS NOT LOADED. PRACTICE SAFE FIREARM HANDLING PROCEDURES AT ALL TIMES.

Set the rail onto the base. Align and set the crossbolts into the cut grooves of the base, and tighten each crossbolt with the help of a coin or screwdriver.

**⚠ CAUTION** MAKE SURE THAT THE SIGHT IS NOT IN CONTACT WITH THE PISTOL, AND THAT NO PART OF IT BLOCKS THE OPERATION OF THE ACTION. AVOID OVER-TIGHTENING THE SCREWS ON THE BASE.

#### 4. FOCUSING THE SIGHT

**CAUTION** DIRECT VIEWING OF THE SUN CAN CAUSE PERMANENT EYE DAMAGE. DO NOT ATTEMPT TO VIEW THE SUN WITH EITHER THIS PRODUCT OR THE NAKED EYE.

#### 5. ZEROING THE SIGHT

**CAUTION** BE SURE THAT THE PISTOL IS NOT LOADED. PRACTICE SAFE FIREARM HANDLING PROCEDURES AT ALL TIMES.

*Zero sighting can be done either manually or with an optical collimator (Bore Sighter):*

- 1) Move the sight back and forth until the correct eye relief distance is achieved.
- 2) Tighten the crossbolt nuts.
- 3) Attach the collimator.

**CAUTION** IF THE BORE STUD DOES NOT INSERT EASILY, REMOVE AND VERIFY THAT THE CORRECT STUD IS BEING USED.

- 4) Look through the scope and into the collimator. Inside you will see a reference grid. If necessary, rotate the collimator until the grid lines match vertically and horizontally with the reticle vectors.
- 5) Adjust the windage and elevation turrets until the Red Dot lines up with the center of the collimator's grid.

Pre-zeroing the scope is now complete. Remove the collimator and bore stud from the barrel and secure it in the supplied case.

**⚠ CAUTION** EYE AND EAR PROTECTION IS STRONGLY RECOMMENDED. SAFE GUN HANDLING PROCEDURES MUST BE USED AT ALL TIMES. ALL DISCHARGING OF FIREARMS SHOULD BE DONE AT AN APPROVED RANGE OR EQUALLY SAFE AREA.

**⚠ WARNING** IF A BORE SIGHTING COLLIMATOR OR ANY OTHER BORE OBSTRUCTING DEVICE WAS USED, IT MUST BE REMOVED BEFORE PROCEEDING. AN OBSTRUCTION CAN CAUSE SERIOUS DAMAGE TO THE GUN AND POSSIBLE PERSONAL INJURY TO YOURSELF OR OTHERS NEARBY.

- 6) At an approved range or other safe area, complete the zeroing procedures. Make approximately one-half of the required windage correction, then approximately one-half of the required elevation correction.

Finish by applying the balance of windage and elevation correction. Making large adjustments in two small increments will prevent damage to the scope's spring.

From a steady rest position, fire three rounds at a target 50 yards away. Observe the point of impact on the target and adjust windage and elevation screws as needed to correct aim, and move the reticle to the area of the target where the three bullets impacts are (see page 11). Repeat if necessary.

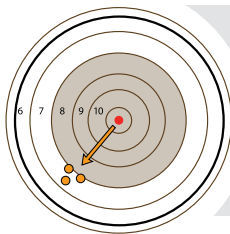

To place the center of the reticle (red) on the point of impact (orange), turn the elevation turret counter-clockwise to raise the point of impact. Then, turn the windage turret counter-clockwise to move the point to impact to the left.



**BE CERTAIN THAT THE PISTOL IS NOT LOADED, THE ACTION IS OPEN, AND THE MUZZLE IS POINTED IN A SAFE DIRECTION. SAFE GUN HANDLING PROCEDURES MUST BE USED AT ALL TIMES.**

## 6. BATTERY REPLACEMENT

### How To Replace The Battery:

With a coin or screwdriver, unscrew the battery cap. Place the battery with the positive side up (+ symbol), then replace the cap in the housing firmly to make sure that it is water-tight.

Duracell model DL2032, Sunrise model CR2032, Energizer model ECR2032.

Turn the switch on, turn the switch knob clockwise to increase the intensity of the reticle brightness, and counterclockwise to decrease it.

## 7. MAINTAINING YOUR ILLUMINATED SIGHT

DO NOT attempt to disassemble or clean the sight internally. This will invalidate the warranty. If the scope requires repairs or adjustment, complete instructions can be found in the warranty.

The external optical surfaces should occasionally be wiped clean with the lens cloth provided, a soft lint-free cloth, or an optical quality lens paper. Keep the protective lens covers in place when the scope is not in use. Remove any external dirt or sand with a soft brush to avoid scratching the finish. Wipe the scope with a damp cloth, following with a dry cloth. Store the unit in a moisture-free environment.

---

---

## **B. Tactical Flashlight**

(62120US002)



**BE CERTAIN THAT YOUR PISTOL IS UNLOADED AND POINTING IN A SAFE DIRECTION.**



**SPECIFICATIONS:**

- 80 Lumen
- Class 3a (<5mW) output power
- One (1) CR123 battery

- Aluminum chassis
- Momentary pressure switch, 8" in length
- Mounting rail for 3/8" grooved receiver
- Mounting rail for 5/8" "weaver-style" bases

## 1.) SELECTING THE CORRECT RAIL MOUNT FOR YOUR PISTOL

The Flashlight attaches to either a 3/8" grooved receiver or to a 5/8" "weaver-style" base. The laser is shipped with the mounting rails for a "weaver-style" mount already installed. If you need to attach this device to a 3/8" grooved receiver, you will need to loosen the rail screw and rotate the 5/8" weaver rail so the the 3/8" is visible.

## 2.) ATTACHING THE CORRECT MOUNT TO THE DEVICE

Simply slide the appropriate rail onto your gun and tighten it into place utilizing the rail attaching screw. Note the "weaver-style" rail utilizes a lock screw to prevent its slippage under recoil. This lock screw should be fit into the groove found on most "weaver-style" mounts.

## 3.) ACTIVATING THE FLASHLIGHT

 **WARNING** DO NOT LOOK DIRECTLY INTO THE FLASHLIGHT BEAM OUTPUT APERTURE DURING OPERATION. PERMANENT EYE DAMAGE MAY RESULT.

### 3A.) Installing The Batteries

Your new flashlight is powered by (1) one CR123 battery. Rotate push button counter clockwise to remove. Insert batter (+) end facing out. Install push button switch by rotating clockwise until tight.

### 3B.) Main On-Off Switch

With this switch, you may turn the laser on or off.



### 3C.) Momentary Pressure Switch

This switch allows you to turn the unit on or off with pressure. The pressure switch access panel at the rear of the device must first be opened. Open this panel by applying pressure on its top and rotating it down. Push the pin connector on the end of the pressure switch firmly into the port. The pressure pad has an adhesive on its end and may be attached to a convenient location on your gun.

---

---

## C. Laser Sight

(62120US003)

**⚠ WARNING** BE CERTAIN THAT YOUR PISTOL IS UNLOADED AND POINTING IN A SAFE DIRECTION.

**⚠ CAUTION** THIS LASER TARGET DESIGNATOR IS A POWERFUL DEVICE THAT REQUIRES SPECIAL ATTENTION FOR ITS USE. READ THE FOLLOWING INSTRUCTIONS AND SAFETY PRECAUTIONS CAREFULLY BEFORE USE.

**⚠ CAUTION** USE OF CONTROLS OR ADJUSTMENTS OR PERFORMANCE OF PROCEDURE OTHER THAN SPECIFIED HEREIN MAY RESULT IN HAZARDOUS RADIATION EXPOSURE.

**⚠ CAUTION** **LASER LIGHT:** AVOID DIRECT EYE EXPOSURE. KEEP OUT OF REACH OF CHILDREN. DO NOT DIRECT LASER AT PEOPLE, PETS, SHINY/HIGHLY REFLECTIVE SURFACES, OR ANY OTHER OBJECT NOT INTENDED FOR DESIGNATED USE.

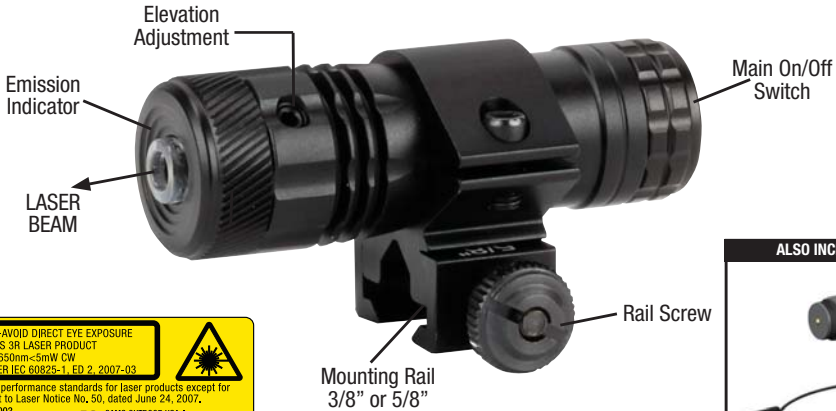

Warning Label:

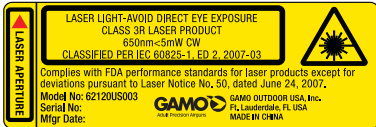

**SPECIFICATIONS:**

- 650nm index-guided laser diode
- Class 3a (<5mW) output power
- Three (3) LR44 lithium batteries
- Advanced composite body
- Momentary pressure switch, 8" in length
- Mounting rail for 3/8" grooved receiver
- Mounting rail for 5/8" "weaver-style" bases
- Visible range:  
Indoor lighting conditions: 100 yards  
Outdoors at night: 300 yards

**CAUTION** Risk of Explosion if battery is replaced by an incorrect type. Dispose of used batteries according to the instructions.

## 1.) SELECTING THE CORRECT RAIL MOUNT FOR YOUR PISTOL

The laser attaches to either a 3/8" grooved receiver or to a 5/8" "weaver-style" base. The laser is shipped with the mounting rails for a "weaver-style" mount already installed. If you need to attach this device to a 3/8" grooved receiver, you will need to loosen the rail screw and rotate the 5/8" weaver mounting rail so the 3/8" is visible.

## 2.) ATTACHING THE CORRECT MOUNT TO THE DEVICE

**CAUTION** BE CERTAIN THAT YOUR PISTOL IS UNLOADED AND POINTING IN A SAFE DIRECTION.

Simply slide the appropriate rail onto your gun and tighten it into place utilizing the rail attaching screw. Note the "weaver-style" rail utilizes a lock screw to prevent its slippage under recoil. This lock screw should be fit into the groove found on most "weaver-style" mounts.

## 3.) ACTIVATING THE LASER

**WARNING** DO NOT LOOK DIRECTLY INTO THE LASER BEAM OUTPUT APERTURE DURING OPERATION. PERMANENT EYE DAMAGE MAY RESULT.

### 3A.) Installing The Batteries

Your new laser is powered by (3) three long-life lithium batteries. Rotate push button counter clockwise to remove. Insert batter (+) end facing out. Install push button switch by rotating clockwise until tight.

### 3B.) Main On-Off Switch

With this switch, you may turn the laser on or off.

### 3C.) Momentary Pressure Switch

This switch allows you to turn the unit on or off with pressure. The pressure switch access panel at the rear of the device must first be opened. Open this panel by applying pressure on its top and rotating it down. Push the pin connector on the end of the pressure switch firmly into the port. The pressure pad has an adhesive on its end and may be attached to a convenient location on your pistol.

### 3D.) Emission Indicator

Your laser is equipped with an emission indicator at the end that the laser projects from. The indicator glows red when the laser is functioning.

## 4.) ALIGNING THE LASER WITH THE PATH OF THE PELLET

**⚠ WARNING** DO NOT LOOK DIRECTLY INTO THE LASER BEAM OUTPUT APERTURE DURING OPERATION. PERMANENT EYE DAMAGE MAY RESULT.

**⚠ WARNING** EXERCISE SAFE GUN HANDLING. SHOOT ONLY AT AN APPROVED GUN RANGE OR SUITABLE LOCATION. USE EYE AND EAR PROTECTION AS NECESSARY.

4A.) Activate the laser by either the pressure switch or the main switch.

4B.) Carefully fire (3) three shots.

4C.) Observe the bullet's strike on the target. To move the point of impact, there are two screw ports at the front of the device. The one marked "E" will move the point of impact up and down (Elevation) and the one marked "W" will move the point of impact left and right (Windage).

**⚠ WARNING** BE CERTAIN THAT YOUR GUN IS UNLOADED AND POINTING IN A SAFE DIRECTION.

4D.) With the smaller of the two included hex wrenches, make the appropriate adjustments. When adjusting windage, rotating the screw clockwise (as viewed from behind the device) will move the dot to the right and your point of impact to the left. When adjusting elevation, rotating the screw clockwise (as viewed from behind the device) will move the dot down and your point of impact up. Note that the adjustments are very sensitive. One half rotation, 180 degrees, will provide approximately 15 inches of movement at 25 yards. After adjustment, carefully fire three more shots and note their strike on the target. Make additional adjustments as necessary.

### 5.) REPLACING THE BATTERIES

The batteries included with your laser target designator will provide long service. However, should the dot grow dim, the batteries may need to be replaced. To do so, remove the battery cap as detailed in section (3A). Next, turn the device up side down and the batteries should fall out. Should the batteries fail to fall free, gently press on the side of the top of the battery with a pen point, toothpick, or similar probe.

*For further safety information regarding lasers, refer to ANSI-Z136.1  
STANDARD FOR THE SAFE USE OF LASERS, available from the Laser Institute of America at:  
(407) 380-1553 or from GAMO OUTDOOR USA®, Inc.*

---

---

### **D. Spare Magazine** (62120US001)



**Double-Sided Magazine**  
Each side holds 8 Rounds  
(16 rounds total)

## ONE (1) YEAR LIMITED WARRANTY

GAMO warrants this product to be free of original defects in material and workmanship for one (1) year. This warranty applies only to goods purchased in the USA. At its option, GAMO will repair or replace this product without charge for parts and labor, providing our inspection indicates that an original defect exists. Should GAMO choose to replace the product, and the product is no longer available at the time warranty service is required, a substitution of similar performance and equal or greater value will be made. This warranty does not include damage caused by abuse, unauthorized repair or modification of any kind. **There are no warranties that extend beyond the description on the face hereof. Gamo makes no implied warranty of merchantability or implied warranty of fitness (for a particular purpose).** Some states do not allow limitations of implied warranty, so this limitation may not apply to you. In that event, any such implied warranty is limited to that required by law. GAMO shall not be liable for incidental or consequential damages, including but not limited to lost profits or other economic or commercial losses. The sole remedy provided in this warranty is repair or replacement of the product. To activate this warranty you must mail within 60 days the enclosed GAMO warranty card to:

**GAMO OUTDOOR USA, Inc.  
3911 SW 47th Avenue, Suite 914  
Ft. Lauderdale, Florida 33314  
Phone (954) 581-5822  
E-Mail: [info@gamoussa.com](mailto:info@gamoussa.com)**

Include with your product a note explaining the nature of the problem and be sure to indicate your name, address, and telephone number. Also include a check or money order in the amount of \$10.00 to cover postage and handling. In the event of a non-warranty repair, you will receive an estimate prior to any work being done. This warranty gives you specific legal rights and you may have other rights which vary from state to state. As defined by federal law, this is a limited warranty.