

Daisy®
FIRST IN AIRGUNS.

POWERLINE®
753

Single Pump Pneumatic Pellet Rifle

OPERATION MANUAL

.177 Cal. (4.5mm) Lead Airgun Pellet 



⚠ CAUTION: NOT A TOY. THIS AIRGUN IS DESIGNED ESPECIALLY FOR CONTROLLED AND SUPERVISED TRAINING USE ONLY. CARELESS USE MAY RESULT IN SERIOUS INJURY OR DEATH. DANGEROUS WITHIN 257 YARDS (235 METERS).

THIS IS A SPECIAL CLASS OF NON-POWDERED GUNS AND NOT FOR GENERAL USE. IT IS TO BE USED FOR TRAINING AND TARGET SHOOTING UNDER SUPERVISION. THIS GUN SHOOTS PELLETS ONLY. THE PURCHASER AND USER SHOULD CONFORM TO ALL LAWS GOVERNING THE USE AND OWNERSHIP OF AIRGUNS.

WARNING: THIS GUN CAN CAUSE DEATH. READ AND FOLLOW THE INSTRUCTIONS CAREFULLY. DO NOT LOAD A PELLET INTO THE CHAMBER UNTIL YOU ARE READY TO SHOOT. IF YOU DO LOAD A PELLET AND DECIDE NOT TO SHOOT, REMOVE IT EITHER MANUALLY OR BY SHOOTING IT IN A SAFE DIRECTION. AN UNCOCKED, UNLOADED GUN IS SAFEST. ACCIDENTS HAPPEN FAST, AND ACCIDENTALLY INJURING OR KILLING SOMEONE IS A TERRIBLE THING. PLEASE SHOOT SAFELY.

This safety alert symbol indicates important safety messages in this manual. When you see this symbol, be alert to the possibility of personal injury and carefully read the message that follows.

The "Introducing Power Line Shooting" section of this book, which begins on Page 11, tells about the rules of shooting safety. **READ THIS SECTION.** Follow the safety rules and make certain anyone using your gun has been instructed in proper gun handling and safety.

Although your new Power Line 753 is not a firearm, it has lethal potential and should be treated with the caution and respect due any conventional firearm. This gun shoots with more muzzle energy than a standard spring air gun. More power means greater chance of serious injury. Use extreme caution when operating this air gun. Be sure to read the rules for proper gun handling on Page 13.

Always remember, the first and most important safety feature of any gun is the shooter. All safeties are mechanical devices and the shooter is the only part of the system that can make a gun safe—or unsafe. **DON'T DEPEND ON MECHANICAL SAFETIES**—think ahead and avoid situations that might lead to accidents.

Guns differ in their operation, and you are never ready to fire any gun until you are thoroughly familiar with it. Read the following operating instructions and **WITHOUT LOADING ANY AMMUNITION**, proceed through the operating steps, dry firing your gun several times at a safe target. This will enable you to learn to operate the Power Line 753 properly and safely.

HOW TO OPERATE

WARNING: BE SURE GUN IS ALWAYS POINTED IN A SAFE DIRECTION.

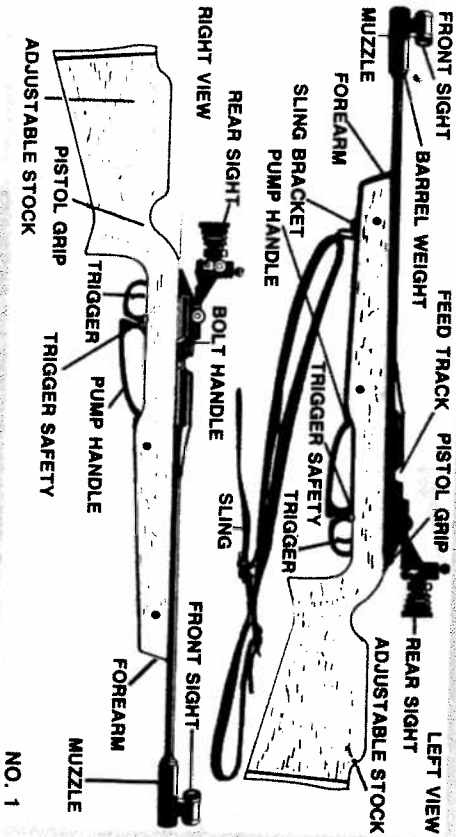

2

- Step 1. PUT "ON" TRIGGER SAFETY
- Step 2. OPEN BOLT
- Step 3. PUMP ONCE
- Step 4. LOAD

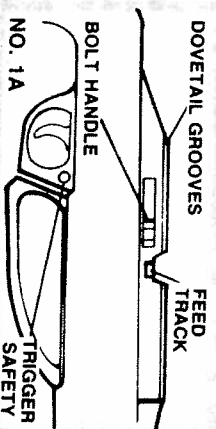

- Step 5. CLOSE BOLT
- Step 6. AIM AT SAFE TARGET
- Step 7. TAKE "OFF" TRIGGER SAFETY
- Step 8. FIRE

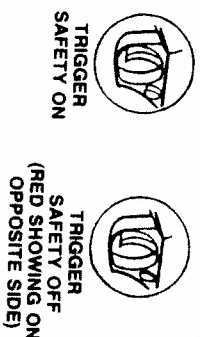

Step 1. PUT "ON" TRIGGER SAFETY

Push the trigger safety from left to right (no red showing). It is a good practice to get into the habit of always keeping the trigger safety "ON" until actually ready to fire the gun. (See Drawing No. 1A.)

Step 2. OPEN BOLT

Pull the bolt handle fully to the rear. Then, release your hold on the bolt handle, leaving the bolt open. The gun cannot fire with the bolt open. (See Drawing No. 1B.)

Step 3. PUMP (ONCE)

IMPORTANT: Do not pump over one time. This gun is designed to produce maximum velocity using a single pump stroke. Additional pump strokes may result in serious damage to the gun.

Grasp the pump handle. Pull out and forward as far as possible. You should hear a fresh charge of air being drawn into the pump cylinder. Then, return the pump lever to the original, closed position. (See Drawing No. 2.)

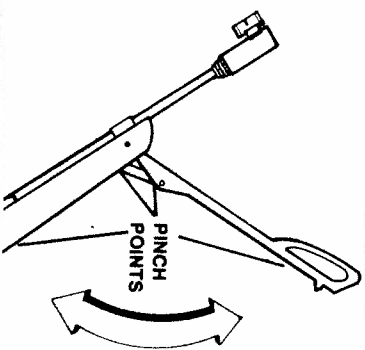
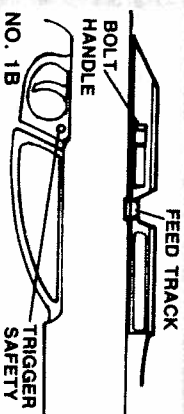

PULL LEVER OUTWARD FOR FULL STROKE THEN RETURN TO THE CLOSED POSITION

NO. 2

3

CAUTION: Be sure to grasp pump handle firmly as you close the lever to prevent it from snapping back and causing possible injury. Also, be careful to keep fingers out of pumping mechanism when closing lever (see "Pinch Points," Drawing No. 2). For greater safety, we recommend that the bolt remain open while pumping and that you close the bolt only when the barrel can be pointed in a safe direction.

CAUTION: If gun is left pumped for an extended period of time OR pumped more than once, all of the air may not be expelled when the gun is shot. This could result in a second pellet being shot without the gun having been pumped. Also, leaving your gun pumped for more than one hour could result in damage to your gun.

Step 4. LOAD

With the bolt back, lower the muzzle slightly and load a pellet, solid end forward (See Drawing No. 3).

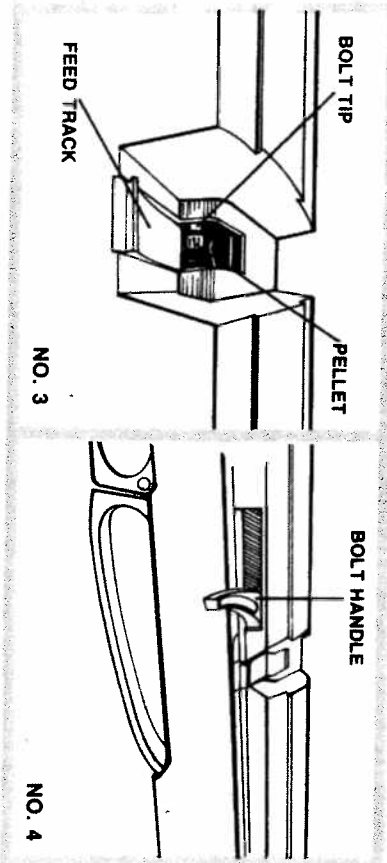

Step 5. CLOSE BOLT

Push the bolt handle fully forward. This will chamber a pellet and lock the bolt. (See Drawing No. 4.) The gun will not fire if the bolt is open.

CAUTION: The gun is now loaded and ready to fire.

Step 6. AIM AT SAFE TARGET

Aim the gun at a safe target.

To be a consistent marksman, use the correct sight picture each time you fire your gun (See Drawing No. 5).

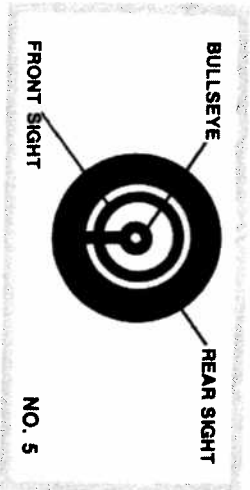

CAUTION: Due to the power of this air gun, use extra caution in selecting a safe target backstop. Pellet guns should not be used with BB gun target backstops. Pick targets that cannot be penetrated or that will not cause ricochet because of their hard surface. Use only targets and traps that are designed for use with high-powered pellet guns. Do not shoot at the surface of water.

Step 7. TAKE "OFF" TRIGGER SAFETY

When you are certain the target, backstop and surrounding area are safe, push the trigger safety from the right, fully to the left (red showing on left). Your gun is now cocked and ready to shoot. In this condition, it should be handled with extreme care.

Step 8. FIRE

After making sure the gun is pointed in a safe direction, gently but firmly squeeze the trigger. Repeat steps 1 through 8 to continue shooting.

WARNING: If a pellet does not fire after completing the operating steps, the gun is jammed. This is a dangerous condition. Keep the gun pointed in a safe direction and perform the following steps:

1. Put the trigger safety "ON" (no red showing).
2. Open bolt.
3. Pump the gun, close bolt and with gun pointed in a safe direction, take the trigger safety "OFF" and fire the gun.

If the pellet still does not fire, follow these steps carefully:

1. Put the trigger safety "ON" (no red showing).
2. Open bolt.
3. Clear barrel by running a cleaning rod through from the muzzle end. Be careful not to damage the bolt tip by pushing the rod through too hard. Do not re-use the pellet.
4. Repeat operating steps 1 through 8. If a pellet is not fired after following the firing procedure, return your gun to the factory Service Department (See "Repair of Daisy Guns" section in this manual).

UNLOAD PELLET

The bolt does not extract a pellet. You must shoot the pellet out if a safe target is available. If a safe target is not available, put trigger safety "ON" (no red showing), open bolt, insert a cleaning rod in the muzzle end and push the pellet out of the barrel. Invert the gun so that the pellet can fall out of the feed track. Be careful not to damage the bolt tip by pushing the rod through too hard. Do not reuse the pellet.

CAUTION: Never assume the gun is empty of projectiles. Always point the gun in a safe direction.

AMMUNITION

Use only .177 caliber (4.5mm) lead air gun pellets. Daisy No. 557 Match Pellets or Daisy No. 555 International Match Pellets are recommended for use in the Model 753. These pellets are uniform in size with minimal weight variations. The flat-wad-cutting designed head will punch a clean hole to provide for easier and more accurate scoring. Daisy pellets are engineered to produce maximum accuracy in the Model 753.

REAR SIGHT INSTALLATION AND ADJUSTMENT

This is a universal target sight with a rubber eyepiece, which prevents light reflecting from the sight into your eye.

Installation: Mounting is accomplished on the dovetailed receiver of the 753 by loosening the mounting screw and plate, and sliding the sight onto the dovetail grooves of the receiver. Position sight where you want it in relation to your eyesight and/or physique. Tighten mounting screw securely.

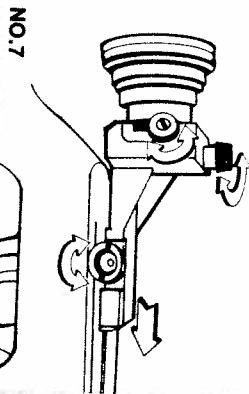
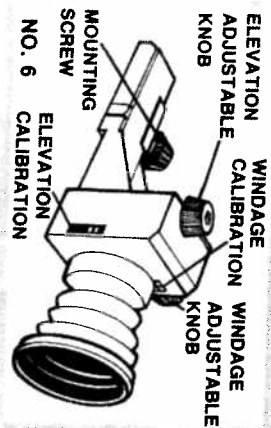

ELEVATION: To lower the point of impact, turn elevation knob to the left (counterclockwise). To raise the point of impact, turn elevation knob to the right (clockwise). Per arrow and word "UP" (See Drawing No. 7).

WINDAGE: To move the point of impact to the left, turn the windage knob counterclockwise. To move the point of impact to the right, turn the windage knob clockwise.

Note: This precision peep sight is fully adjustable. Its micrometer mechanism is gauged to adjust 0.002 of an inch or 0.0508 millimeter per click.

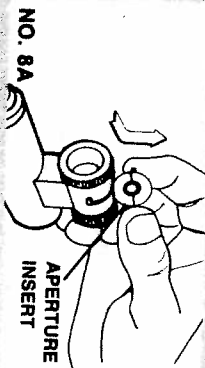
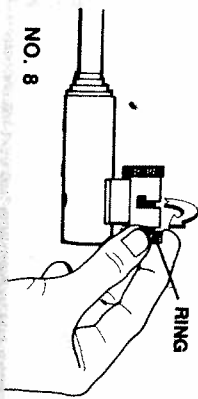

FRONT SIGHT APERTURE INSERTS

Your Model 753 comes with four aperture inserts, with one already in place. To change inserts, follow this procedure:

1. Point the muzzle up and away from you.
2. Grip the knurled ring at the back of the sight and turn counterclockwise. If tight, a coin may be used in the slots.
3. Unscrew until aperture is free to be removed by using finger and thumb on side of sight tube, engaging ears on aperture to pull back and upwards.

Note: Apertures have ears of different sizes to ensure the proper positioning when replaced.

6

4. To install, make sure back locking ring is unscrewed far enough for clearance. Have ears used to proper side. Insert in groove and push forward. Tighten locking ring. A coin may be used to assure a firm lock.

SLING ATTACHMENT

The sling is attached to the Model 753 by a detachable sling swivel which connects to a sling bracket on the forward end of the cocking lever. With the sling attached to the swivel and then pulled back along the underside of the rifle, the tab end of the sling should be hanging down (See Drawing No. 9).

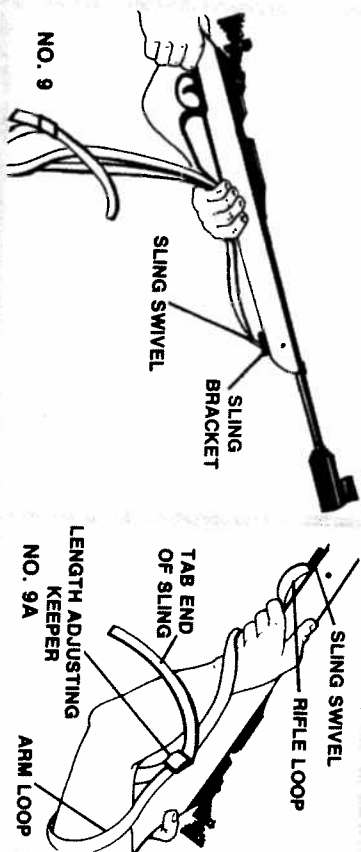

PUTTING SLING ON ARM:

1. Open the arm loop.
2. Turn loop one quarter turn in the direction of the sling arm (i.e., one quarter turn to the left if the sling is going on the left arm) and slip your arm into the loop (See Drawing 9A).
3. Place sling loop on your upper arm either above the bicep near the shoulder or below the bicep.
4. Tighten the sling loop until it is snug enough to remain in place on your arm. It should not be so tight that it restricts the flow of blood in your arm or creates a pulse effect.

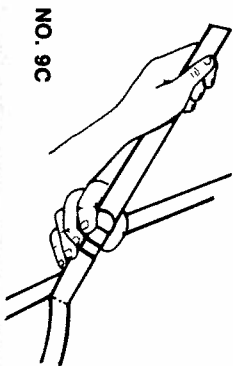
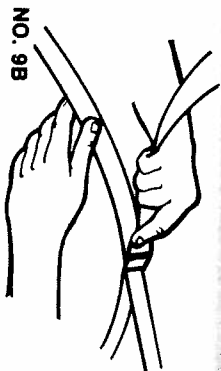

LENGTHENING SLING: Grasp the tab end of the keeper with your trigger hand and lift it up while pulling on the top strand (not the tab end) of the sling (See Drawing No. 9B).

SHORTENING SLING: Pull the tab end of the sling away from you until sling reaches the desired length (See Drawing 9C).

7

Stock Adjustment:

To adjust stock, loosen screws in buttplate sufficiently to allow insertion of the desired number of spacers (See Drawing No. 10). Spacers go between stock and buttplate. Each insert will adjust stock length 5/8 inch (625 inch). After stock adjustment inserts have been added, tighten buttplate screws to lock inserts in place. To shorten the stock reverse this procedure. Be certain spacers are placed so the molded cleats nest in the molded receptacle.

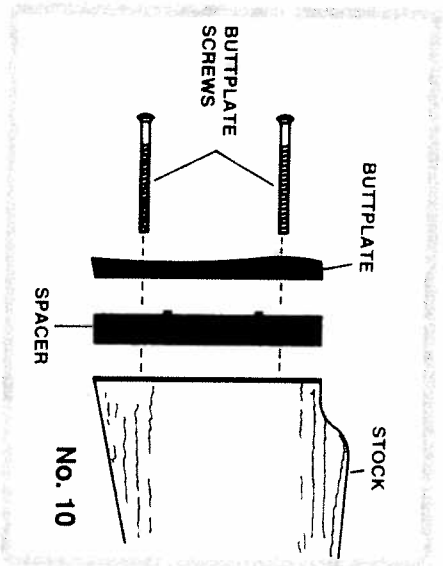

NOTE: Be careful not to damage the sealing tip on the bolt when the rod tip enters the loading area. It may be necessary to clean the barrel approximately every 50 shots to maintain maximum accuracy. Frequent cleaning may be necessary when the gun is new, and until excess oil is removed from the pump system.

LUBRICATION

Your Model 753 should be lubricated approximately once every 1,000 shots. Lubricate the pump piston foam wiper ring by inverting the gun and opening the lever fully. You will see "Oil Here." Oil the felt wiper which can be seen through a slot in the pump tube. Add oil, drop-by-drop, until the wiper appears saturated.

The pump lever pivot joints should be lubricated sparingly by adding one or two drops of oil to each pivot pin (See Drawing No. 11).

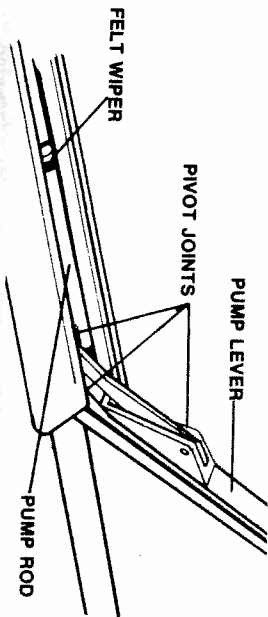

CAUTION: Improper lubricants, such as aerosol type spray lubricants, can ignite (diesel) during pumping. Use only automotive motor oils.

IMPORTANT: The only oils recommended for use on the Model 753 are 10-, 20-, or 30-weight, automotive motor oils. DO NOT use light, household type oils or aerosol type spray lubricants since they may contain substances or additives harmful to the rubber seals and other components.

STORAGE

To make your Model 753 safe for storage or transporting, proceed through operating steps 1 through 8, omitting Step 4 (Loading), **WHILE POINTING THE GUN IN A SAFE DIRECTION WHEN YOU GO THROUGH THESE STEPS!** Then put the trigger safety "ON" (no red showing). This will ensure that the hammer is fired, that no air is stored in the pump system, that there is not a pellet in the chamber and that the trigger safety is "ON." Always store pellets in a place separate from the gun to keep them from untrained shooters. Before putting your gun away, make sure it is clean, dry, oiled, unloaded and uncocked. If the gun is to be stored for a long period of time, a light coat of oil in the barrel will help prevent corrosion.

MODIFICATION

CAUTION: The components of your gun have been engineered to deliver optimum performance. Any modification or tampering with the gun may cause a malfunction and may make it unsafe to use. Any change in performance, such as a lowered trigger force or shortened trigger travel, indicates possible wear. In such cases, qualified personnel should inspect and, if necessary, repair or replace the gun. Any gun that has been dropped should be checked by qualified personnel to insure that its function has not been effected.

PROPER CARE

With care, periodic cleaning and lubrication, your Model 753 will provide many years of shooting enjoyment. As is the case with conventional firearms, abuse, neglect and continued exposure to the elements will impair the performance of any air gun. Learn to take care of your Model 753 and it will serve you well.

CAUTION: Never attempt to clean the Model 753 until you put the trigger safety in the "ON" position (no red showing), have made absolutely certain that the gun is not loaded and have the bolt in the fully open position.

Stock and Forearm: The wooden stock may be wiped clean with a damp rag, and lightly waxed.

Exterior Parts:

Exposed metal parts (i.e., receiver, barrel, etc.) should occasionally be wiped clean using a soft, lightly oiled cloth. Use a clean motor oil.

Barrel:

The barrel should be cleaned occasionally to maintain accuracy. We recommend using Daisy's No. 5875 Cleaning Kit. To clean barrel, open bolt and insert cleaning rod and oil saturated patches into the muzzle end of the bore. Retract the rod and patch from the barrel. Repeat this procedure several times with oiled patches, then switch to dry patches. Continue using dry patches until most of the oil is removed from the bore.

REPAIR OF DAISY GUNS

WARNING: A GUN THAT IS NOT OPERATING PROPERLY MAY BE DANGEROUS. IT SHOULD BE KEPT SAFELY FROM USE BY ANYONE UNTIL REPAIRED OR DESTROYED. DO NOT TRY TO TAKE THE GUN APART. IT IS DIFFICULT TO REASSEMBLE, AND IMPROPER REASSEMBLY CAN CAUSE A HAZARDOUS CONDITION.

GUNS IN WARRANTY

LIMITED ONE-YEAR WARRANTY

For one year from date of purchase, Daisy will repair or replace and return this gun, free of charge, if defective in material or workmanship. Service is available by returning the gun to Daisy Manufacturing Co., Inc. Attach your name, address, telephone number, description of problem and proof of date of retail purchase (sales slip) to the gun. Package and send, transportation prepaid, to Daisy Manufacturing Co., Inc. This warranty gives you specific legal rights, and you may also have other rights which vary from state to state.

GUNS OUT OF WARRANTY

If your Daisy needs repair, attach your name, address and brief description of problem to the gun. Package and send, transportation prepaid, to Daisy Manufacturing Co., Inc., Service Department. Daisy will repair the gun or replace it with a reconditioned gun of the same model. A charge for repairing or replacing the gun will be sent to you by return mail. Mail your check or money order (not cash) in payment of the charge. Your gun will then be repaired or replaced and shipped to you.

Exploded gun part drawings and price lists are available from Daisy Service Department. When ordering, please make sure you state the model number (either imprinted on the barrel or molded into the receiver). Service and parts charges are subject to change without notice.

Daisy Manufacturing Company, Inc.
Service Department
2111 South 8th
Fogers, Arkansas 72756, U.S.A.

NOTE: Power Line airguns do not come under the provisions of the "Gun Control Act of 1968" and so can be mailed.

MODEL 753 SPECIFICATIONS

ACTION	Single pump pneumatic, single shot pellet
CALIBER	.177 cal. (4.5mm)
AMMUNITION	.177 cal. (4.5mm) lead air gun pellets
FRONT SIGHT	Globe type with apertures
REAR SIGHT	Peep sight with micrometer click, screw adjustment
BARREL	Rifled steel with barrel weight
MUZZLE VELOCITY	510 fps (156 mps)
MUZZLE ENERGY	4.5 ft. lb. (6.0J)
TARGET DISTANCE	33 ft. (10m)
MAXIMUM SHOOTING DISTANCE*	257 yds (235)
ADD ON ACCESSORIES	Standard dovetail mount on receiver to accept a scope; nylon web sling
STOCK	Target style with adjustable buttplate for trigger pull length.

*With the muzzle pointed upward at the optimum angle